



ALTAIR

Altair[®] FluxMotor[®] 2023.1

Synchronous machines – Permanent magnets - Inner & Outer rotor

Motor Factory – Test - Working point

General user information

Contents

1	Working point – Sine wave – Motor – I, Ψ, N	9
1.1	Overview	9
1.1.1	Positioning and objective	9
1.1.2	User inputs	10
1.1.3	Main outputs	10
1.1.3.1	Main results	10
1.1.3.2	Curves – in the “Fast computation modes”	10
1.1.3.3	Curves – in the “Accurate computation modes”	10
1.1.3.4	Graphics	10
1.1.3.5	Temperatures	10
1.2	Settings	11
1.2.1	Thermal settings	11
1.2.2	Power electronics parameters	11
1.2.3	Mechanical loss model parameters	12
1.3	Inputs	12
1.3.1	Introduction	12
1.3.2	Standard inputs	12
1.3.2.1	Modes of computation	12
1.3.2.2	Current definition mode	12
1.3.2.3	Line current, rms	12
1.3.2.4	Current density, rms	12
1.3.2.5	Control angle	13
1.3.2.6	AC losses analysis	13
1.3.2.7	Speed	14
1.3.2.8	Ripple torque analysis	14
1.3.2.9	Additional losses	14
1.3.3	Advanced inputs	14
1.3.3.1	Number of computed electrical periods	14
1.3.3.2	Number of points per electrical period	14
1.3.3.3	Number of computations per ripple torque period	14
1.3.3.4	Rotor initial position	15
1.3.3.5	Skew model – Number of layers	15
1.3.3.6	Mesh order	15
1.3.3.7	Airgap mesh coefficient	15
1.3.3.8	Convergence criteria on temperature	15
1.4	Main principles of computation	16
1.4.1	Introduction	16
1.4.2	Fast computation mode	16
1.4.2.1	Working point - Definition	16
1.4.2.2	Electromagnetic behavior – General information	16
1.4.2.3	Flux in airgap	16
1.4.2.4	Flux density in iron	17
1.4.2.5	Magnet behavior	17
1.4.2.6	Ripple torque	17
1.4.3	Accurate computation mode	18
1.4.3.1	Working point - Definition	18
1.4.3.2	Electromagnetic behavior – General information	18
1.4.3.3	Iron losses	18
1.4.3.4	Magnet losses	18
1.4.3.5	Stator Joule winding losses	18

1.4.3.6	Flux density in iron	19
1.4.3.7	Magnet behavior	19
1.4.3.8	Torque	19
1.4.3.9	Flux in airgap	19
1.4.3.10	Phase voltage	19
1.4.3.11	Phase current	19
1.5	Test results	20
1.5.1	Test conditions	20
1.5.1.1	Inputs	20
1.5.1.2	Settings	20
1.5.1.3	Winding and magnet characteristics	20
1.5.2	Main results	20
1.5.2.1	Machine performance – Working point	20
1.5.2.2	Power electronics	20
1.5.2.3	Ripple mechanical torque	21
1.5.3	Curves - Fast	21
1.5.4	Curves - Accurate	21
1.5.5	Isovalues and isolines	21
1.5.6	Chart and table of temperatures	22
1.5.7	Limitation of thermal computations - Advice for use	22
2	Working point – Sine wave – Motor – T, N	23
2.1	Overview	23
2.1.1	Positioning and objective	23
2.1.2	User inputs	23
2.1.3	Main outputs	24
2.1.3.1	Tables of results	24
2.1.3.2	Curves	24
2.2	Settings	24
2.3	Inputs	24
2.3.1	Introduction	24
2.3.2	Standard inputs	24
2.3.2.1	Mechanical torque	24
2.3.2.2	Speed	24
2.3.2.3	Command mode	25
2.3.2.4	Ripple torque analysis	25
2.3.2.5	Additional losses	25
2.3.3	Advanced inputs	26
2.3.3.1	Number of computations for J_d , J_q	26
2.3.3.2	Number of computations per ripple torque period	26
2.3.3.3	Rotor initial position	26
2.3.3.4	Skew model – Number of layers	26
2.3.3.5	Mesh order	27
2.3.3.6	Airgap mesh coefficient	27
2.4	Main principles of computations	28
2.4.1	Overview	28
2.4.2	Base speed point	28
2.4.2.1	Initialization of the computation	28
2.4.2.2	Computation of the base speed point	29
2.4.3	Electromagnetic behavior	29
2.4.3.1	Introduction	29
2.4.3.2	Flux in airgap	29
2.4.3.3	Flux density in iron	29

2.4.3.4	Magnet behavior	29
2.4.4	Ripple torque	30
2.4.4.1	Original computation of the electromagnetic torque	30
2.4.4.2	Mechanical ripple torque based on Park's model	30
2.4.4.3	Resulting mechanical torque versus rotor angular position	30
2.4.5	Maximum speed estimation	30
2.5	Test results	31
2.5.1	Test conditions	31
2.5.1.1	Inputs	31
2.5.1.2	Settings	31
2.5.1.3	Winding and magnet characteristics	31
2.5.2	Main results	31
2.5.2.1	Machine performance – Working point	31
2.5.2.2	Power electronics	31
2.5.2.3	Ripple mechanical torque	32
2.5.3	Curves	32
3	Working point – Sine wave – Motor – I, U	33
3.1	Overview,	33
3.1.1	Positioning and objective	33
3.1.2	User inputs	33
3.1.3	Main outputs	33
3.1.3.1	Tables of results	34
3.1.3.2	Curves	34
3.2	Settings	34
3.3	Inputs	35
3.3.1	Introduction	35
3.3.2	Standard inputs	35
3.3.2.1	Current definition mode	35
3.3.2.2	Maximum line current, rms	35
3.3.2.3	Maximum current density, rms	35
3.3.2.4	Command mode	35
3.3.2.5	Ripple torque analysis	35
3.3.2.6	Additional losses	35
3.3.3	Advanced inputs	36
3.3.3.1	Number of computations for control angle	36
3.3.3.2	Number of computations per ripple torque period	36
3.3.3.3	Rotor initial position	36
3.3.3.4	Skew model – Number of layers	37
3.3.3.5	Mesh order	37
3.3.3.6	Airgap mesh coefficient	37
3.4	Main principles of computation	38
3.4.1	Introduction	38
3.4.2	Base speed point	38
3.4.3	Electromagnetic behavior	39
3.4.3.1	Introduction	39
3.4.3.2	Flux in airgap	39
3.4.3.3	Flux density in iron	39
3.4.3.4	Magnet behavior	39
3.4.4	Ripple torque	39
3.4.4.1	Original computation of the electromagnetic torque	39
3.4.4.2	Mechanical ripple torque based on Park's model	39
3.4.4.3	Resulting mechanical torque versus rotor angular position	40

3.4.5	Maximum speed estimation	40
3.5	Test results	41
3.5.1	Test conditions	41
3.5.1.1	Inputs	41
3.5.1.2	Settings	41
3.5.1.3	Winding and magnet characteristics	41
3.5.2	Main results	41
3.5.2.1	Machine performance – Working point	41
3.5.2.2	Power electronics	41
3.5.2.3	Ripple mechanical torque	42
3.5.3	Curves	42
4	Working point – Sine wave – Generator – I, Ψ, N	43
4.1	Overview	43
4.1.1	Positioning and objective	43
4.1.2	User inputs	44
4.1.3	Main outputs	44
4.1.3.1	Tables of results	44
4.1.3.2	Curves – in the “Fast computation modes”	44
4.1.3.3	Curves – in the “Accurate computation modes”	44
4.1.3.4	Graphics	44
4.1.3.5	Temperatures	44
4.2	Settings	45
4.2.1	Thermal settings	45
4.2.2	Mechanical loss model parameters	46
4.3	Inputs	46
4.3.1	Introduction	46
4.3.2	Standard inputs	46
4.3.2.1	Computation modes	46
4.3.2.2	Current definition mode	46
4.3.2.3	Line current, rms	46
4.3.2.4	Current density, rms	46
4.3.2.5	Control angle	47
4.3.2.6	AC losses analysis	47
4.3.2.7	Speed	47
4.3.2.8	Ripple torque analysis	48
4.3.2.9	Additional losses	48
4.3.3	Advanced inputs	48
4.3.3.1	Number of computed electrical periods	48
4.3.3.2	Number of points per electrical period	48
4.3.3.3	Number of computations per ripple torque period	48
4.3.3.4	Rotor initial position	49
4.3.3.5	Skew model – Number of layers	49
4.3.3.6	Mesh order	49
4.3.3.7	Airgap mesh coefficient	49
4.3.3.8	Convergence criteria on temperature	49
4.4	Main principles of computation	50
4.4.1	Introduction	50
4.4.2	Fast computation mode	50
4.4.2.1	Working point - Definition	50
4.4.2.2	Electromagnetic behavior – General information	51
4.4.2.3	Flux in airgap	51
4.4.2.4	Flux density in iron	51

4.4.2.5	Magnet behavior	51
4.4.2.6	Ripple torque	51
4.4.3	Accurate computation mode	52
4.4.3.1	Working point - Definition	52
4.4.3.2	Electromagnetic behavior – General information	52
4.4.3.3	Iron losses	52
4.4.3.4	Magnet losses	52
4.4.3.5	Stator Joule winding losses	53
4.4.3.6	Flux density in iron	53
4.4.3.7	Magnet behavior	53
4.4.3.8	Torque	54
4.4.3.9	Flux in airgap	54
4.4.3.10	Phase voltage	54
4.4.3.11	Phase current	54
4.5	Test results	55
4.5.1	Test conditions	55
4.5.1.1	Inputs	55
4.5.1.2	Settings	55
4.5.1.3	Winding and magnet characteristics	55
4.5.2	Main results	55
4.5.2.1	Machine performance – Working point	55
4.5.2.2	Ripple mechanical torque	55
4.5.3	Curves - Fast	56
4.5.4	Curves - Accurate	56
4.5.5	Isovalues and isolines	56
4.5.6	Chart and table of temperatures	57
4.5.7	Limitation of thermal computations - Advice for use	57
5	Working point – Sine wave – Generator – R, L load & speed	58
5.1	Overview	58
5.1.1	Positioning and objective	58
5.1.2	User inputs	58
5.1.3	Main outputs	59
5.1.3.1	Tables of results	59
5.1.3.2	Curves	59
5.2	Settings	59
5.3	Inputs	60
5.3.1	Introduction	60
5.3.2	Standard inputs	60
5.3.2.1	Load resistance	60
5.3.2.2	Load inductance	60
5.3.2.3	Speed	60
5.3.2.4	Ripple torque analysis	60
5.3.2.5	Additional losses	60
5.3.3	Advanced inputs	61
5.3.3.1	Number of computations per ripple torque period	61
5.3.3.2	Rotor initial position	61
5.3.3.3	Skew model – Number of layers	61
5.3.3.4	Mesh order	61
5.3.3.5	Airgap mesh coefficient	62
5.3.3.6	Convergence criteria on current	62
5.4	Main principle of computation	63
5.4.1	Steady state behavior	63

5.4.2	Electromagnetic behavior	64
5.4.2.1	Introduction	64
5.4.2.2	Flux in airgap	64
5.4.2.3	Flux density in iron	64
5.4.2.4	Magnet behavior	64
5.4.3	Ripple torque	64
5.4.3.1	Original computation of the electromagnetic torque	64
5.4.3.2	Mechanical ripple torque based on Park's model	64
5.4.3.3	Resulting mechanical torque versus rotor angular position	65
5.5	Test results	65
5.5.1	Test conditions	65
5.5.1.1	Inputs	65
5.5.1.2	Settings	65
5.5.1.3	Winding and magnet characteristics	65
5.5.2	Main results	66
5.5.2.1	Machine performance – Open circuit	66
5.5.2.2	Machine performance – Working point.	66
5.5.2.3	Ripple mechanical torque	66
5.5.3	Curves	66
6	Working point – Square wave – Motor – Forced I	67
6.1	Overview	67
6.1.1	Positioning and objective	67
6.1.2	User inputs	68
6.1.3	Main outputs	68
6.1.3.1	Tables of results	68
6.1.3.2	Curves	68
6.2	Settings	69
6.3	User inputs	69
6.3.1	Introduction	69
6.3.2	Standard inputs	69
6.3.2.1	Current definition mode	69
6.3.2.2	Current density, peak	69
6.3.2.3	Line current, peak	69
6.3.2.4	Speed	69
6.3.2.5	Control angle	70
6.3.2.6	Conduction angle	70
6.3.2.7	Rise and fall angle	70
6.3.2.8	Iron loss computation	71
6.3.2.9	Losses in magnets computation	71
6.3.2.10	Additional losses	71
6.3.3	Advanced inputs	72
6.3.3.1	Minimum number of computations per electrical period	72
6.3.3.2	Rotor initial position	72
6.3.3.3	Skew model – Number of layers	72
6.3.3.4	Mesh order	72
6.3.3.5	Airgap mesh coefficient	73
6.3.4	Main principles of computation	74
6.3.4.1	Introduction	74
6.3.4.2	Working point	74
6.3.4.3	Computation of iron losses	75
6.3.4.4	Computation of magnet losses	75
6.4	Test results	75

6.4.1	Test conditions	75
6.4.1.1	Inputs	75
6.4.1.2	Settings	75
6.4.1.3	Winding and magnet characteristics	75
6.4.2	Main results	76
6.4.2.1	Machine performance – Working point	76
6.4.2.2	Ripple mechanical torque	76
6.4.3	Curves	76

1 WORKING POINT – SINE WAVE – MOTOR – I, Ψ , N

1.1 Overview

1.1.1 Positioning and objective

The aim of the test “**Working point – Sine wave – Motor – I, Ψ , N**” is to characterize the behavior of the machine when operating at the targeted input values I, Ψ , N (Magnitude of current, Control angle, Speed).

These three inputs are enough to impose a precise working point.

For instance, a working point can be chosen on the efficiency map, by identifying the current, the control angle and the speed with different curves or maps displayed in the “Performance mapping / Sine wave / Motor / Efficiency map” test. Then, the “Working point – Sine wave – Motor – I, Ψ , N” test allows to compute the performance for this working point.

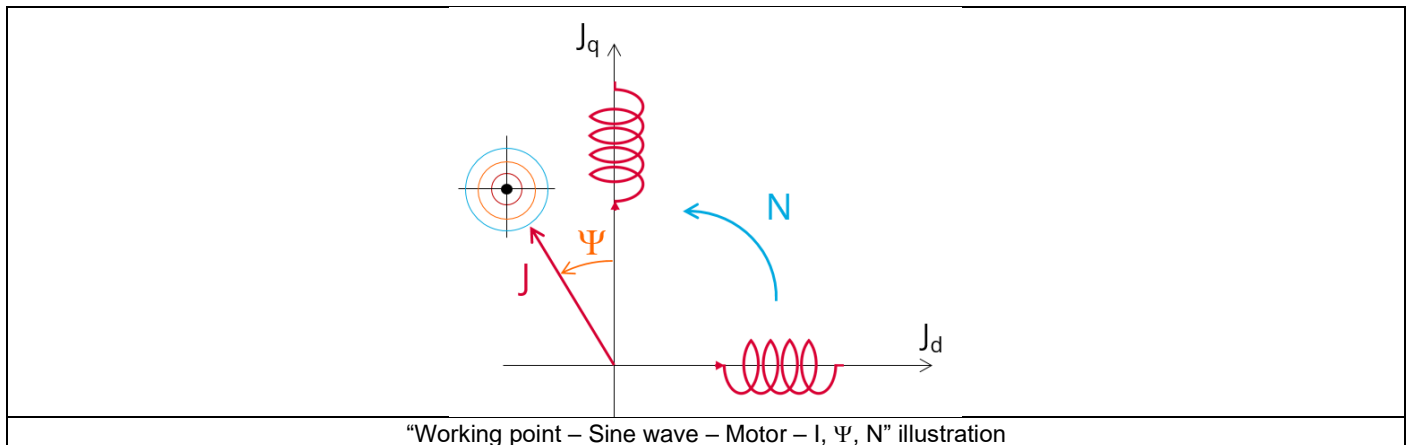

The results of this test give an overview of the electromagnetic analysis of the machine considering its topology.

The general data of the machine, like machine constants, power balance and magnet behavior are computed and displayed. The motor convention is used to build the model.

The magnetic flux density is also computed in every region of the machine’s magnetic circuit to evaluate the design.

Two computation modes are available:

- “Fast computation mode” is perfectly suited for the pre-design step (Hybrid model based on Magneto-Static Finite Element computations and Park transformation theory)
- “Accurate computation mode” is perfectly suited for the final design step (Pure Finite Element modeling based on transient computations)

It also gives the capability to make comparisons between the results obtained from the measurements and those obtained with Altair® FluxMotor®.

When both the following conditions are met, this test allows to perform electromagnetic computations with coupled thermal analysis.

- The type of machine is Synchronous Machine with Permanent Magnets with Inner rotor
- One of the two following thermal solving modes is selected: One iteration or iterative solving mode

The following table helps to classify the test “Working point – Sine wave – Motor – I, Ψ , N”.

Family	Working point
Package	Sine wave
Convention	Motor
Test	I, Ψ , N

Positioning of the test “Working point – Sine wave – Motor – I, Ψ , N”

1.1.2 User inputs

The four main user input parameters are the supply line current, control angle, speed, and the computation mode. In addition, temperatures of winding and magnets must be set.

1.1.3 Main outputs

Test results are illustrated with data, graphs, and tables

1.1.3.1 Main results

- 1) Machine performance – Base speed point
 - General data
 - Machine constants
 - Power balance
 - Flux in airgap
 - Flux density in iron
 - Magnet behavior including evaluation of demagnetization rate
- 2) Power electronics
 - Inverter
 - Working point
- 3) Ripple mechanical torque
 - Working point
- 4) Thermal data
 - Table of temperatures

1.1.3.2 Curves – in the “Fast computation modes”

- 1) Ripple mechanical torque versus rotor angular position
- 2) Flux density in airgap versus rotor angular position
- 3) Chart of temperature (radial and axial views)

1.1.3.3 Curves – in the “Accurate computation modes”

- 1) Mechanical torque versus rotor angular position
- 2) Mechanical torque harmonic analysis
- 3) Flux density in airgap versus rotor angular position
- 4) Flux density in airgap harmonic analysis
- 5) Phase voltage versus rotor angular position
- 6) Phase voltage harmonic analysis
- 7) Phase current versus rotor angular position
- 8) Phase current harmonic analysis

1.1.3.4 Graphics

- 1) Isovalues

1.1.3.5 Temperatures

- 1) Chart of temperature (radial and axial views)
- 2) Thermal data
 - Table of temperatures

1.2 Settings

Three buttons give access to the following setting definition: Thermal, Electronics and Mechanics. Each kind of settings is briefly defined here.

Additional information can be read in the document: MotorFactory_SMPM_IOR_3PH_Test_Introduction – sections dealing with settings.

1.2.1 Thermal settings

In the thermal settings you have two main possible choices:

- Either you can define the temperatures of active components (Magnet and winding) to define the physical properties of the materials needed to run directly the tests without any thermal computation.
- Or you can choose between two other ways to run the test: iterative process until convergence or a single iteration process to perform electromagnetic computation coupled to thermal analysis.

1	Dialog box to define the thermal settings. Buttons allow to choose one of the three thermal solving modes
2	The first option of thermal setting is to run the test with only electromagnetic computation without any thermal analysis. This option is the default one available for all the tests.
2a	Dialog box that allows to define the machine active components winding and magnets temperatures to run test without any thermal analysis.
2b	Temperatures of the machine active components to be considered for characterizing the physical properties of the associated materials.
3	Thermal solving mode with only one iteration between electromagnetic and thermal computations.
4	Thermal solving mode with iterative process between electromagnetic and thermal computations till the convergence.
5	Initial temperatures of the machine active components winding and magnets. These temperatures are used to initialize the electromagnetic-thermal process of computation.
6	Definition of coolant temperatures to be considered: <ul style="list-style-type: none"> • External fluid temperature ⁽¹⁾ • Cooling circuit fluid inlet temperature (when a cooling circuit is defined on the design side ⁽²⁾)

Notes

(1) The external fluid temperature corresponds to the temperature of the fluid surrounding the machine. It is also considered as the temperature at the “infinite” for the computation of radiation from the frame to the “infinite”.

(2) The cooling circuit fluid temperature is relevant only when a cooling circuit has been added by the user in the design environment. In this case, this input describes its fluid inlet temperature.

For more details, please refer to the document: MotorFactory_SMPM_IOR_3PH_Test_Introduction – section “thermal settings”.

1.2.2 Power electronics parameters

Dialog box to define the power electronics parameters:

- Inverter control strategy
- Inputs for evaluating the power electronics stage losses

For more details, please refer to the document: MotorFactory_SMPM_IOR_3PH_Test_Introduction – sections dealing with “Power electronics mode settings”.

1.2.3 Mechanical loss model parameters

A dialog box allows defining the mechanical loss computation model.

For more details, please refer to the document: MotorFactory_SMPM_IOR_3PH_Test_Introduction – section “Mechanical loss model settings”.

1.3 Inputs

1.3.1 Introduction

The total number of user inputs is equal to 13.

Among these inputs, 7 are standard inputs and 6 are advanced inputs.

1.3.2 Standard inputs

1.3.2.1 Modes of computation

There are 2 modes of computation.

The “**Fast**” computation mode is the default one. It corresponds to a hybrid model which is perfectly suited for the pre-design step. Indeed, all the computations in the back end are based on magnetostatic finite element computations associated to Park transformation. It evaluates the electromagnetic quantities with the best compromise between accuracy and computation time to explore the space of solutions quickly and easily.

The “**Accurate**” computation mode allows solving the computation with transient magnetic finite element modelling. This mode of computation is perfectly suited to the final design step because it allows getting more accurate results. It also computes additional quantities like the AC losses in winding, rotor iron losses and Joule losses in magnets.

1.3.2.2 Current definition mode

There are 2 common ways to define the electrical current.

Electrical current can be defined by the current density in electric conductors.

In this case, the current definition mode should be « **Density** ».

Electrical current can be defined directly by indicating the value of the line current (the rms value is required).

In this case, the current definition mode should be « **Current** ».

1.3.2.3 Line current, rms

When the choice of current definition mode is “**Current**”, the rms value of the line current supplied to the machine: “**Line current, rms**” (*Line current, rms value*) must be provided.

1.3.2.4 Current density, rms

When the choice of current definition mode is “**Density**”, the rms value of the current density in electric conductors “**Current density, rms**” (*Current density in conductors, rms value*) must be provided.

Note: The number of parallel paths and the winding connection are automatically considered in the results.

1.3.2.5 Control angle

Considering the vector diagram shown below, the “**Control angle**” is the angle between the electromotive force (E) and the electrical current (J) ($\Psi = (E, J)$).

The default value is 45 degrees. It is an electrical angle. It must be set in a range of -90 to 90 degrees.

This range of values covers all the possible working points in the motor convention. The operating mode is displayed at the head of results.

Note: The sign of results like power depends on both the convention and the operating mode.

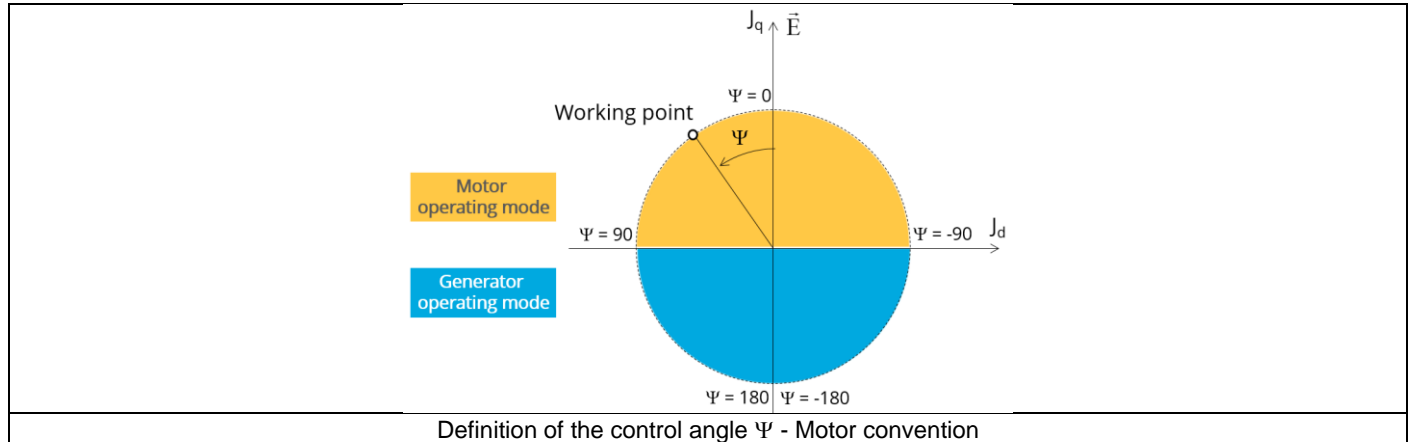

1.3.2.6 AC losses analysis

The “**AC losses analysis**” (AC losses analysis required only while “Accurate” computation mode is selected) allows computing or not AC losses in stator winding. There are three available options:

None: AC losses are not computed. However, as the computation mode is “Accurate”, a transient computation is performed without representing the solid conductors (wires) inside the slots. Phases are modeled with coil regions. Thus, the mesh density (number of nodes) is lower which leads to a lower computation time.

FE-One phase: AC losses are computed with only one phase modeled with solid conductors (wires) inside the slots. The other two phases are modeled with coil regions. Thus, AC losses in winding are computed with a lower computation time than if all the phases were modeled with solid conductors. However, this can have a little impact on the accuracy of results because we have supposed that the magnetic field is not impacted by the modeling assumption.

FE-All phase: AC losses are computed, with all phases modeled with solid conductors (wires) inside the slots. This computation method gives the best results in terms of accuracy, but with a higher computation time.

FE-Hybrid: AC losses in winding are computed without representing the wires (strands, solid conductors) inside the slots.

Since the location of each wire is accurately defined in the winding environment, sensors evaluate the evolution of the flux density close each wire. Then, a postprocessing based on analytical approaches computes the resulting current density inside the conductors and the corresponding Joule losses.

The wire topology can be “Circular” or “Rectangular”.

There can be one or several wires in parallel (in hand) in a conductor (per turn).

This method leads to quite accurate results with lower computation time. This is a good compromise between accuracy and computation time.

Warning: With the “FE-Hybrid” option the accuracy of results is good especially when the wire size is small (let’s say wire diameter lower than 2.5 mm). However, this can have a little impact on the accuracy of results because we have supposed that the magnetic field is not impacted by the modeling assumption.

Note: With FE-Hybrid option the recommended “Number of computed electrical periods” is equal to “1/2” whereas 2 computed electrical periods are needed for “FE-One phase” and for “FE-All phase” options.

Indeed, when solid conductors are represented in the Finite Element model (like with FE-One phase and FE-All phase options), there are transient phenomena to consider which leads to increase the “Number of computed electrical periods” to reach the steady state.

With the “FE-Hybrid option”, the transient phenomena are handled by the analytical model, so, it is not necessary to increase the “Number of computed electrical periods” compared to a study with “None” options (without AC losses computation).

Note: When the winding is built with a hairpin technology the FE-Hybrid mode is not available because it is not relevant for computations with such kind of winding/conductors.

1.3.2.7 Speed

The imposed “**Speed**” (*Speed*) of the machine must be set.

1.3.2.8 Ripple torque analysis

The “**Ripple torque analysis**” (Additional analysis on ripple torque period: Yes / No) allows to compute or not to compute the value of the ripple torque and to display the corresponding torque versus the angular position over the ripple torque period. The default value is “No”.

Notes:

- This choice influences the accuracy of results and the computation time. The peak-peak ripple torque is calculated. This additional computation needs addition computation time.
- In case of “Yes”, the ripple torque is computed. Then, the flux density in regions and the magnet demagnetization rate are evaluated through the ripple torque computation.
- In case of “No”, the ripple torque is not computed. Then, the flux density in regions and the magnet demagnetization rate are evaluated by considering the Park’s model computation.

1.3.2.9 Additional losses

“Additional losses” input is not available in the current version (The input label is written in grey).

1.3.3 Advanced inputs

1.3.3.1 Number of computed electrical periods

The user input “**No. computed elec. periods**” (Number of computed electrical periods only required with “Accurate” computation mode) influences the accuracy of results especially in case of AC losses computation. Indeed, with represented conductors (AC losses analysis set to “FE - One phase” or “FE - All phase”) the computation may lead to have transient current evolution in wires requiring more than an electrical period of simulation to reach the steady state over an electrical period.

The default value is equal to 2. The minimum allowed value is 0.5 (recommended with AC losses analysis set to “None”). The default value provides a good compromise between the accuracy of results and computation time.

1.3.3.2 Number of points per electrical period

The user input “**No. points / electrical period**” (Number of points per electrical period required only with “Accurate” computation mode) influences the accuracy of results (computation of the peak-peak ripple torque, iron losses, AC losses...) and the computation time.

The default value is equal to 40. The minimum recommended value is 20. The default value provides a good balance between accuracy of results and the computation time.

1.3.3.3 Number of computations per ripple torque period

The number of computations per ripple torque period is considered when the user has chosen to perform a “Ripple torque analysis” (i.e. answered “Yes” to the standard input “Ripple torque analysis” required only with “Fast” computation mode).

The user input “**No. comp. / ripple period**” (Number of computations per ripple torque period) influences the accuracy of results (computation of the peak-peak ripple torque) and the computation time.

The default value is equal to 30. The minimum allowed value is 25. The default value provides a good balance between the accuracy of results and computation time.

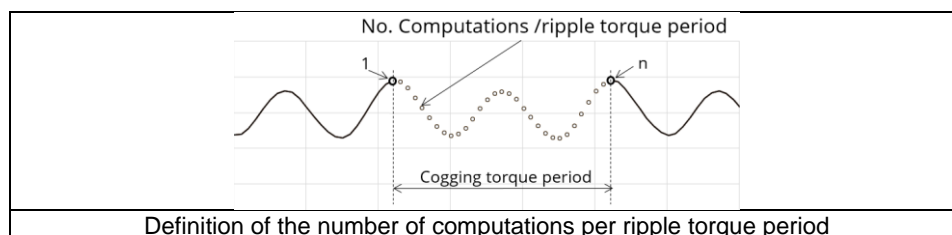

1.3.3.4 Rotor initial position

By default, the “**Rotor initial position**” is set to “**Auto**”.

When the “**Rotor initial position mode**” is set to “**Auto**”, the initial position of the rotor is automatically defined by an internal process of FluxMotor®. The resulting relative angular position corresponds to the alignment between the axis of the stator phase 1 (reference phase) and the direct axis of the rotor north pole.

When the “**Rotor initial position**” is set to “User input” (i.e. toggle button on the right), the initial position of the rotor to be considered for computation must be set by the user in the field « **Rotor initial position** ». The default value is equal to 0. The range of possible values is [-360, 360]. For more details, please refer to the document: MotorFactory_SMPM_IOR_3PH_Test_Introduction – section “Rotor and stator relative position”.

1.3.3.5 Skew model – Number of layers

When the rotor magnets or the stator slots are skewed, the number of layers used in Flux® Skew environment to model the machine can be modified: “**Skew model - No. of layers**” (*Number of layers for modelling the skewing in Flux® Skew environment*).

1.3.3.6 Mesh order

To get the results, the original computation is performed using a Finite Element Modeling.

Two levels of meshing can be considered for this finite element calculation: first order and second order.

This parameter influences the accuracy of results and the computation time.

By default, second order mesh is used.

1.3.3.7 Airgap mesh coefficient

The advanced user input “**Airgap mesh coefficient**” is a coefficient which adjusts the size of mesh elements inside the airgap. When the value of “**Airgap mesh coefficient**” decreases, the mesh elements get smaller, leading to a higher mesh density inside the airgap, increasing the computation accuracy.

The imposed Mesh Point (size of mesh elements touching the points of the geometry), inside the Flux® software, is described as:

$$\text{MeshPoint} = (\text{airgap}) \times (\text{airgap mesh coefficient})$$

Airgap mesh coefficient is set to 1.5 by default.

The variation range of values for this parameter is [0.05; 2].

0.05 gives a very high mesh density and 2 gives a very coarse mesh density.

Caution:

Be aware, a very high mesh density does not always mean a better result quality. However, this always leads to the formation of a huge number of nodes in the corresponding finite element model. So, it means a need of huge numerical memory and increases the computation time considerably.

1.3.3.8 Convergence criteria on temperature

The advanced user input “**Converg. Criteria on temperature**” (*Convergence criteria on temperature*) is a percentage driving the convergence of the computation.

This advanced user input is available when the iterative thermal solving mode is selected in the thermal settings.

The iterative process (loop between electromagnetic and thermal computations) must run until the convergence criteria has been reached leading to the electromagnetic-thermal steady state. The convergence process is completed when the variation of temperature between two iterations gets lower than the ratio “**Converg. Criteria on temperature**” set in input.

Convergence criteria on temperature is set to 1.0 % by default.

The variation range of values for this percentage is]0;10].

A percentage close to zero gives more accurate results, but a longer computation time. A high percentage can make the convergence shorter but decreases the accuracy of the results. The default value of 1.0% gives a good balance between the accuracy and computation time on most of the computations, but a smaller value can also be required to increase the computation accuracy on some working points.

Note: Two conditions are required to make the “Convergence criteria” available:

- The type of machine is Synchronous Machine with Permanent Magnets with Inner rotor (Thermal computations are available only for inner rotor machines)
- One of the two following thermal solving modes is selected: One iteration or iterative computation until convergence mode.

1.4 Main principles of computation

1.4.1 Introduction

The aim of this test in motor convention is to give a good overview of the electromagnetic potential of the machine by characterizing the working point according to the line current, control angle and speed set by the user. In addition, ripple torque at the working point is also computed.

Two computation modes are available:

- “Fast computation mode” is perfectly suited for the pre-design step to explore the space of solutions quickly and easily (Hybrid model based on magnetostatic FE computations and Park transformation)
- “Accurate computation mode” is perfectly suited for the final design step because it allows getting more accurate results and to compute additional quantities like the AC losses in winding, rotor iron losses and Joule losses in magnets (Pure FE model based on transient computations)

1.4.2 Fast computation mode

1.4.2.1 Working point - Definition

To compute the working point, the principle consists of positioning the magnet axis towards the reference phase axis by considering the targeted control angle.

At the same time, the targeted line current and speed are imposed.

Then, the resulting behavior of the machine can be simulated, and all the main electromagnetic characteristics of the machine can be deduced by using Park’s transformation and associated electric equations.

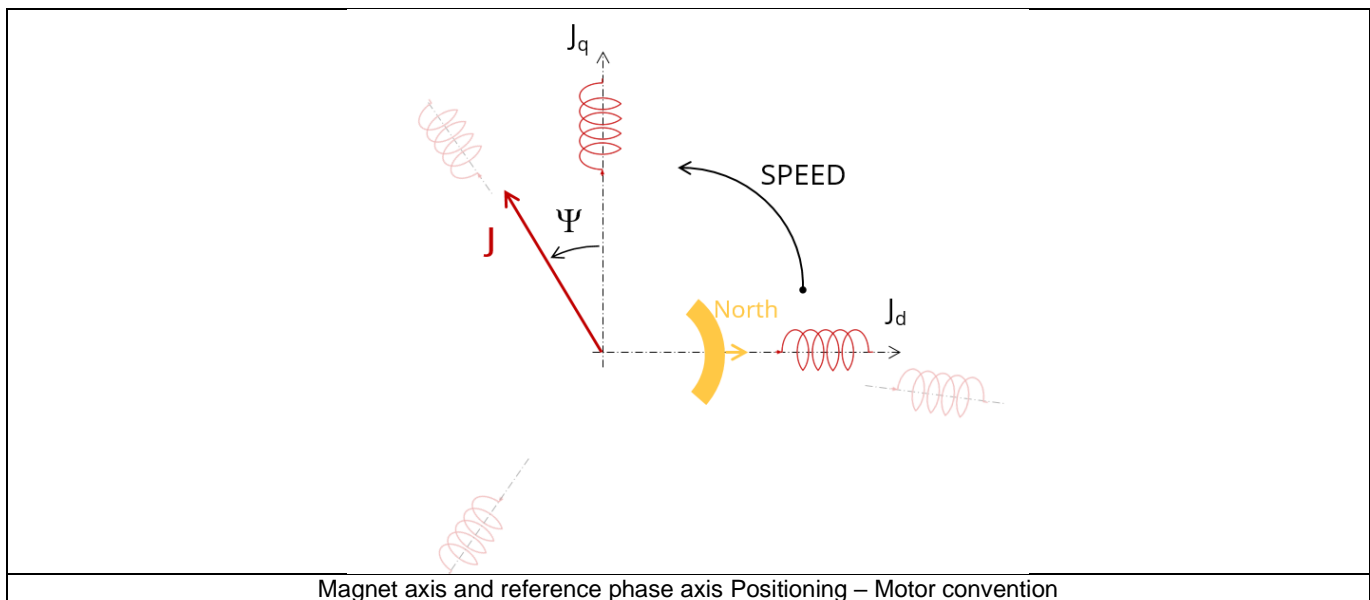

1.4.2.2 Electromagnetic behavior – General information

The method used for computation of electromagnetic behavior depends on if ripple torque analysis is set to “Yes” or “No”:

- “Yes” is selected: The analysis of the electromagnetic behavior is done over one ripple torque period (when torque ripple computation is not performed).
- “No” is selected: The analysis of the electromagnetic behavior is done through a dedicated static computation (1 rotor position to be considered) for the computed working point (with line current, control angle and speed obtained for the working point).

1.4.2.3 Flux in airgap

The flux in the airgap is always computed thanks to the dedicated static computation of the working point.

The airgap flux density is computed along a path in the airgap in Flux® software. The resulting signal is obtained for at least an electric period. The average and the peak value of the flux density are also computed. The harmonic analysis of the flux density in airgap versus rotor position is done to compute the magnitude of the first harmonic of the flux density.

1.4.2.4 Flux density in iron

Mean and maximum values of flux density of each iron region are computed thanks to sensors in Flux® software.

1.4.2.5 Magnet behavior

Mean values of flux density and magnetic field inside the magnets are computed thanks to sensors in Flux® software. Based on these results, demagnetization rate of the magnets is computed.

1.4.2.6 Ripple torque

A specific computation is performed to precisely determine the rate of ripple torque.

Considering J_d and J_q at the base speed point, a computation is performed over one ripple torque period by using Finite Element modelling (Flux® software – Magnetostatic application).

Many computation points are considered over the ripple torque period (advanced user input: **No. comp. / ripple period**).

The following steps are performed to determinate the mechanical torque.

1) Original computation of the electromagnetic torque

The magnetic torque exerted on a non-deformable part of the domain is computed by the virtual work method. The torque in a direction is obtained by deriving the system energy with respect to a virtual displacement of the part in this direction.

The magnetic torque T_{em} is given by the following derivative:

$$T_{em} = -\frac{\partial W_m}{\partial \theta}$$

$\partial \theta$ = elementary angular displacement,

W_m = magnetic energy in the regional volume

The electromagnetic ripple torque is computed over the ripple torque period with respect of the rotor angular position $T_{em,\theta}$. The mean value " $T_{em,mean}$ " can also be computed.

2) Mechanical ripple torque based on Park's model

The mechanical ripple torque must be computed at the base speed.

First, we compute the electromagnetic torque " $T_{em, Park}$ " with Park's model:

$$T_{em, Park} = \frac{m}{2} \times p \times (\Phi_d \times J_q - \Phi_q \times J_d)$$

Then, the iron loss torque, the mechanical loss torque and the additional loss torque are subtracted from " $T_{em, Park}$ " to get the corresponding mean value of the mechanical torque " $T_{mech, Park}$ ".

3) Resulting mechanical torque versus rotor angular position

To compute the resulting mechanical ripple torque, the original electromagnetic torque computed previously is weighted by the ratio of the mean value of the mechanical torque based on Park's model ($T_{mech, Park}$) and of the mean value of the original electromagnetic ripple torque ($T_{em, mean}$).

$$T_{mech,\theta} = T_{em,\theta} \times \frac{T_{mech, Park}}{T_{em, mean}}$$

The peak-peak value of the mechanical ripple torque is then computed. The rate of ripple torque is deduced as a percentage or per unit of the nominal torque.

Warning: When the ripple torque computation is not requested, the computation of the working point is performed by considering only one position within the electrical period. It means that all the data characterizing the behavior of the machine can change based on the selection of ripple torque (Yes/No).

Flux density in magnetic circuit and the magnet behavior will be more accurately computed when the computation of the ripple torque will be requested.

1.4.3 Accurate computation mode

1.4.3.1 Working point - Definition

Working point computation is based on a transient magnetic finite element simulation over a half, one or several electrical periods for a given set of inputs: control angle, line current and speed defined as for the Fast computation mode. Thus, all the main electromagnetic characteristics of the machine can be deduced accurately.

1.4.3.2 Electromagnetic behavior – General information

All the main quantities are directly computed from the Flux® software in the framework of a transient magnetic finite element simulation.

1.4.3.3 Iron losses

Iron losses (stator and rotor) are computed, thanks to the “transient modified Bertotti model” in Flux® software.

1.4.3.4 Magnet losses

Magnet losses are computed thanks to the sensors defined for each corresponding region in Flux® software.

1.4.3.5 Stator Joule winding losses

The stator’s DC Joule losses are always computed.

However, if AC losses analysis is set to “FE-One phase” or “FE-all phase” stator AC Joule losses are computed in addition to stator’s DC Joule losses.

FE-One phase: AC losses are computed with only one phase modeled for solid conductors (wires) inside the slots. The two other ones are modeled with coil regions. Thus, AC losses in winding are computed with a lower computation time than if all the phases were modeled with solid conductors. However, this can have a little impact on the accuracy of results because we have supposed that the magnetic field is not impacted by the modeling assumption.

FE-All phase: AC losses are computed, with all phases modeled with solid conductors (wires) inside the slots. This computation method gives the best results in terms of accuracy, but with a higher computation time.

FE-Hybrid: AC losses in winding are computed without representing the wires (strands, solid conductors) inside the slots.

Since the location of each wire is accurately defined in the winding environment, sensors evaluate the evolution of the flux density close each wire. Then, a postprocessing based on analytical approaches computes the resulting current density inside the conductors and the corresponding Joule losses.

With the “FE-Hybrid” option the accuracy of results is good especially when the wire size is small (let’s say wire diameter lower than 2.5 mm). However, this can have a little impact on the accuracy of results because we have supposed that the magnetic field is not impacted by the modeling assumption.

In FluxMotor®, stator AC Joule losses corresponds to the additional losses induced by fields and skin effects in the conductors (wires) at high speed. Circulating current between parallel path or/and conductor wires are also considered in the modeling. In case of AC losses, the total stator Joule losses ($W_{\text{Stator Joule Tot.}}$) is given by:

$$W_{\text{Stator Joule Tot.}} = W_{\text{Stator DC Joule Tot.}} + W_{\text{Stator AC Joule Tot.}}$$

Each term “AC and DC” are themselves divided in two parts: the “winding active length part” (lamination part) and the “end winding part”.

$$W_{\text{Stator DC Joule Tot.}} = W_{\text{Stator DC Joule W.A.L.}} + W_{\text{Stator DC Joule E.W.}}$$

$$W_{\text{Stator AC Joule Tot.}} = W_{\text{Stator AC Joule W.A.L.}} + W_{\text{Stator AC Joule E.W.}}$$

In the winding active length part (W.A.L), field effect, skin effect and circulating current are considered.

In the end ring part (E.W), field effect and skin effect are neglected, only circulating current are considered. This allows to identify the amount of AC losses induced by circulating current between wires of conductors (Circulating current are induced by the unbalance of impedance of wires of a conductor itself induced by the field variation in conjunction of each wire position in a conductor).

Thanks to AC losses computation, “stator winding resistance ratio” are computed for the “total resistance”, the “Winding Active Length resistance” and the “End Winding resistance”. Ratios are computed by following the below equations:

$$R_{s \text{ AC/DC}} = \frac{W_{\text{Stator DC Joule Tot.}} + W_{\text{Stator AC Joule Tot.}}}{W_{\text{Stator DC Joule Tot.}}}$$

$$R_{s \text{ w.a.l. AC/DC}} = \frac{W_{\text{Stator DC Joule W.A.L.}} + W_{\text{Stator AC Joule W.A.L.}}}{W_{\text{Stator DC Joule W.A.L.}}}$$

$$R_{s \text{ e.w. AC/DC}} = \frac{W_{\text{Stator DC Joule E.W.}} + W_{\text{Stator AC Joule E.W.}}}{W_{\text{Stator DC Joule E.W.}}}$$

1.4.3.6 Flux density in iron

Mean and maximum values of flux density of each iron region are computed with the help of sensors in Flux® software.

1.4.3.7 Magnet behavior

Mean values of flux density and magnetic field inside the magnets are computed thanks to sensors in Flux® software. Based on these results, demagnetization rate of the magnets is computed.

1.4.3.8 Torque

The magnetic torque exerted on a non-deformable part of the domain is computed by the virtual work method. The torque in a direction is obtained by deriving the system energy with respect to a virtual displacement of the part in this direction.

The magnetic torque T_{em} is given by the following derivative:

$$T_{em} = - \frac{\partial W_m}{\partial \theta}$$

$\partial \theta$ = elementary angular displacement,

W_m = magnetic energy in the regional volume

The electromagnetic torque is computed over the electrical period with respect to the rotor angular position $T_{em,\theta}$.

Then, the mean value of the electromagnetic torque is computed " $T_{em, mean}$ ".

The iron loss torque, the mechanical loss torque and the additional loss torque are subtracted from " $T_{em, mean}$," to get the corresponding mean value of the mechanical torque " $T_{mech, mean}$ ". To compute the resulting mechanical ripple torque, the mean electromagnetic torque previously computed is weighted by the ratio of the mean value of the mechanical torque ($T_{mech, mean}$) and the mean value of the original electromagnetic torque ($T_{em, mean}$).

$$T_{mech,\theta} = T_{em,\theta} \times \frac{T_{mech,mean}}{T_{em,mean}}$$

The peak-peak value of the mechanical ripple torque is then computed. The rate of ripple torque is deduced as a percentage or per unit of the nominal torque.

1.4.3.9 Flux in airgap

The airgap flux density is computed with a sensor which is defined in the static part of the airgap under a tooth in Flux® software. The resulting signal is obtained over an electric period. The average and the peak value of the flux density are also computed. The harmonic analysis of the phase voltage is done to evaluate the harmonics content.

1.4.3.10 Phase voltage

The phase voltage is computed with a sensor defined in the electrical circuit in Flux® software. The resulting signal is obtained over an electric period. The harmonic analysis of the phase voltage is done to evaluate the harmonics content.

1.4.3.11 Phase current

The phase current is computed with a sensor defined in the electrical circuit in Flux® software. The resulting signal is obtained over an electric period. The harmonic analysis of the phase voltage is done to evaluate the harmonics content very useful in case of delta winding coupling.

1.5 Test results

Once a test is finished, the corresponding results are automatically displayed in the central window.

1.5.1 Test conditions

1.5.1.1 Inputs

All the parameter values, belonging to standard inputs or advanced inputs are described in this section. It shows the initial conditions considered for the test.

Here are the displayed subsections:

- Context
- Standard parameters
- Advanced parameters

For more information refer to the section 1.3 (Inputs).

1.5.1.2 Settings

All the settings dedicated to the test along with the thermal characteristics are displayed in this section.

Here is the displayed subsection:

- Thermal
- Electronics
- Mechanics

1.5.1.3 Winding and magnet characteristics

All winding and magnet characteristics are displayed in the following subsections:

- Magnet characteristics
- Winding characteristics

For more details, please refer to the document: MotorFactory_SMPM_IOR_3PH_Test_Introduction – section “Machine characteristics”.

1.5.2 Main results

1.5.2.1 Machine performance – Working point

Output data displayed in the following subsections are described in the section Working point – Sine wave – Motor.

Here are the displayed subsections:

- General data
- Machine constants
- Power balance
- Flux in airgap
- Flux density in iron
- Magnet behavior

Output data displayed in the following area list are described in the document: MotorFactory_SMPM_IOR_3PH_Test_Introduction – section Working point – Sine wave – Display of results.

1.5.2.2 Power electronics

- Inverter

When power electronics stage is selected by the user, the inverter control strategy and the DC bus voltage are reminded. For information, the corresponding maximum line-line voltage, rms value is computed and displayed.

- Working point

The power balance and the corresponding efficiencies are computed and displayed for the machine, the power electronics stage and for the system (i.e. machine + power electronics stage).

For more details, please refer to the document: MotorFactory_SMPM_IOR_3PH_Test_Introduction – sections dealing with “Power electronics mode settings”.

1.5.2.3 Ripple mechanical torque

The analysis of the ripple torque is presented in the table “Ripple mechanical torque” with the following subsections:

- Working point

For more details, please refer to the document: MotorFactory_SMPM_IOR_3PH_Test_Introduction – sections dealing with “Working point – Sine wave – Display of results”.

1.5.3 Curves - Fast

- Ripple mechanical torque versus rotor angular position
- Flux density in airgap versus rotor angular position
- Chart of temperature (radial and axial views)

1.5.4 Curves - Accurate

- Mechanical torque versus rotor angular position
- Mechanical torque harmonic analysis
- Flux density in airgap versus rotor angular position
- Flux density in airgap harmonic analysis
- Phase voltage versus rotor angular position
- Phase voltage harmonic analysis
- Phase current versus rotor angular position
- Phase current harmonic analysis

1.5.5 Isovalues and isolines

The flux density isovalues and the vector potential isolines can be displayed.

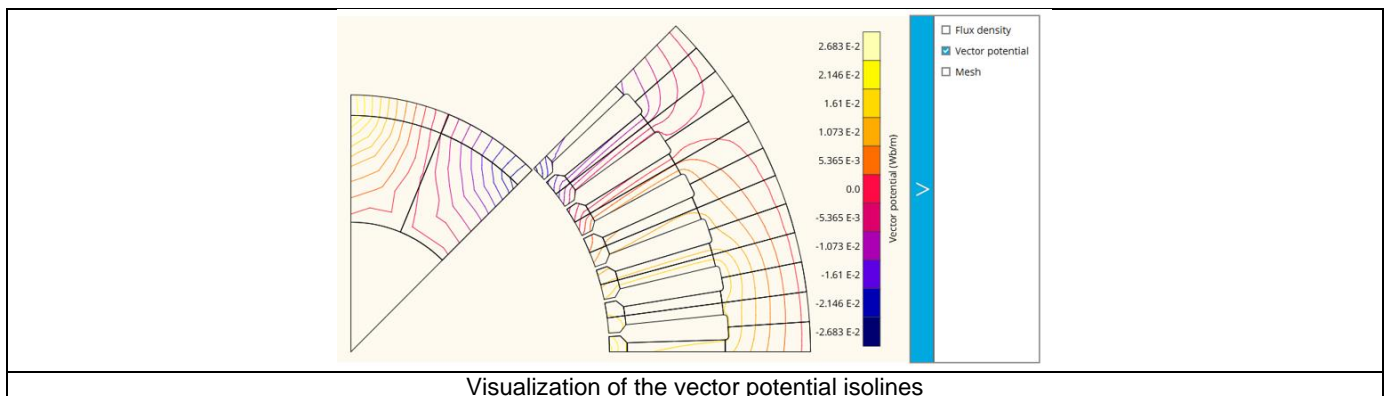
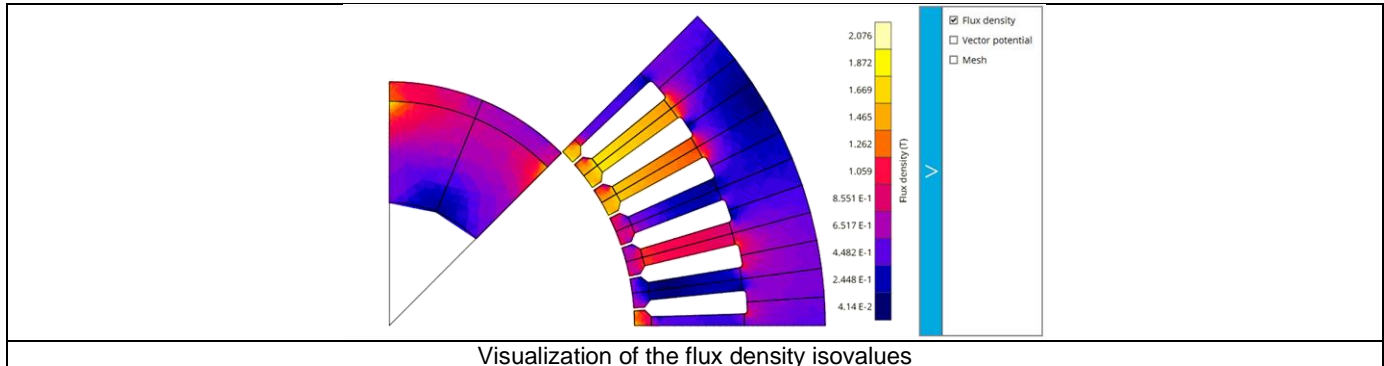

Note: The visualization of the meshing of the model can also be displayed.

1.5.6 Chart and table of temperatures

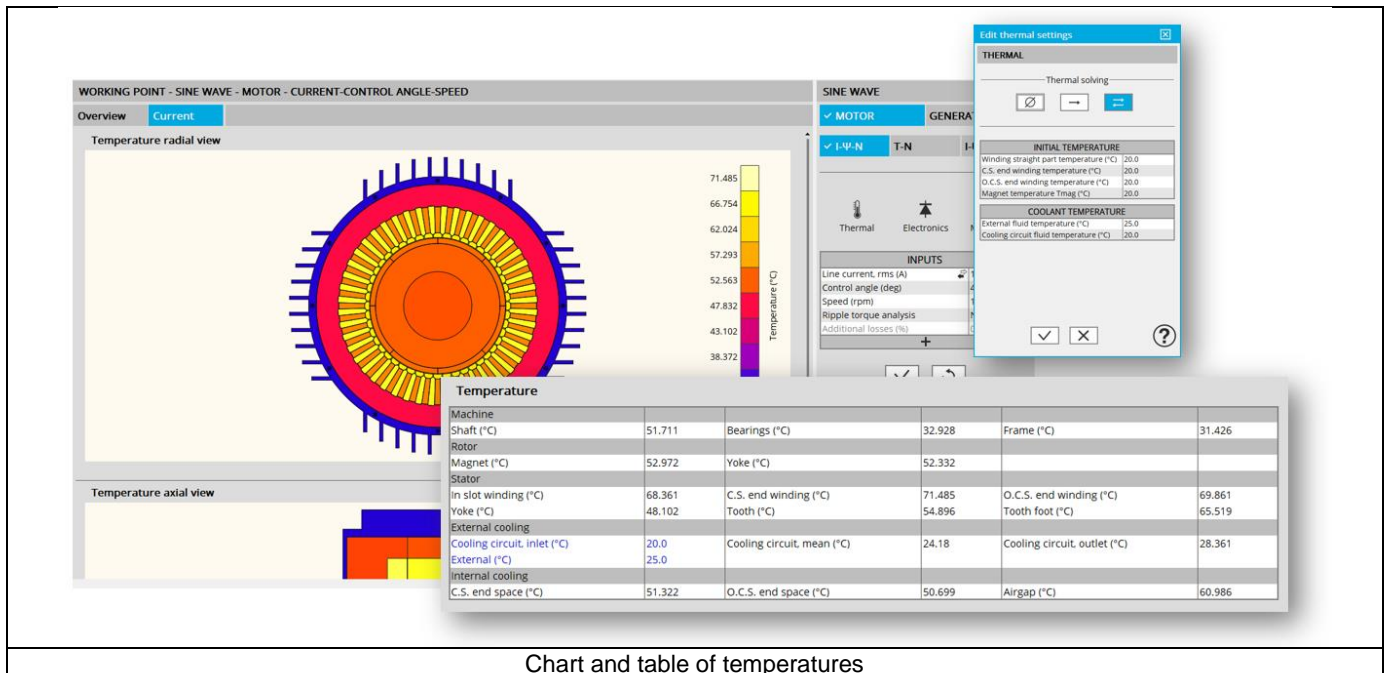

1.5.7 Limitation of thermal computations - Advice for use

Notes:

- Setting a skew angle modifies the electromagnetic performance of the machine, including the losses. For electromagnetic/thermal iterative solving, the losses are then considered as inputs of the thermal computation. This means that in "One iteration" or "Iterative" solving modes, the temperatures reached in the machine will change depending on the skew angle in input.
- The resistance network identification of a machine is always done without any skew angle. This can bring some inaccuracy in the results for highly skewed machines.
- For additional information, please refer to the document: MotorFactory_SMPM_IOR_3PH_Test_Introduction – section "Limitation of thermal computations – Advice for use"

2 WORKING POINT – SINE WAVE – MOTOR – T, N

2.1 Overview

2.1.1 Positioning and objective

The aim of the test “**Working point – Sine wave – Motor – T, N**” is to characterize the behavior of the machine when operating at the working point which is targeted by the user. It corresponds to the base point at a targeted useful torque and speed. The working point torque-speed is defined by considering the targeted input values T, N (useful torque, speed).

This test allows defining the required line-line voltage and line current to reach the targeted useful torque and speed for the considered command mode (MTPV, MTPA or maximum efficiency).

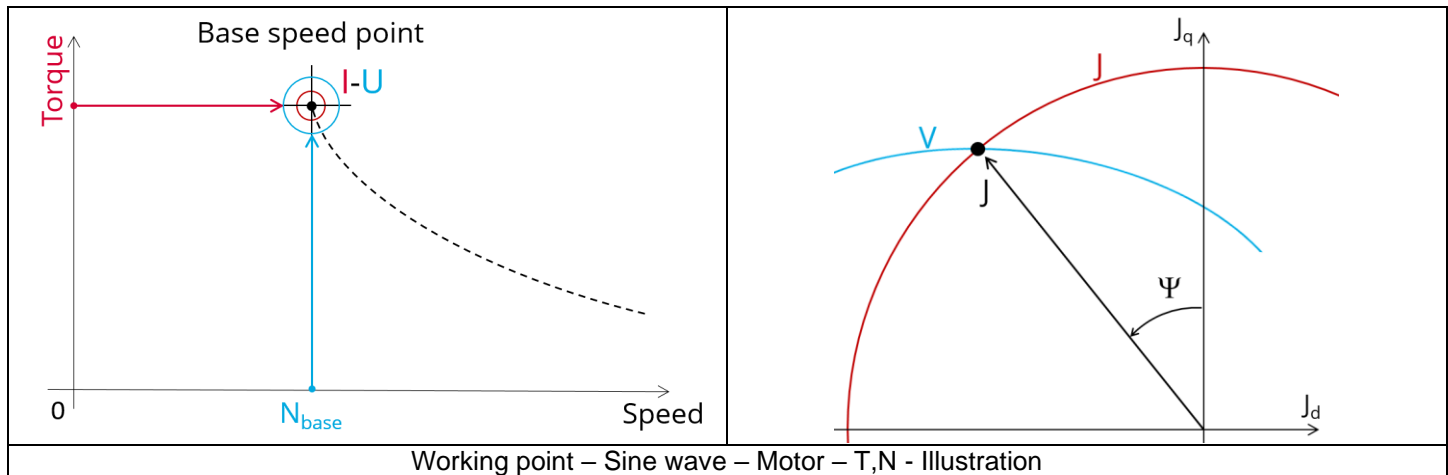

The results of this test give an overview of the electromagnetic analysis of the motor considering the machine topology. The general data of the machine, like machine constants, power balance and magnet behavior are computed and displayed. The magnetic flux density is also computed in every region of the machine magnetic circuit to evaluate the design.

Note: In FluxMotor® terminology, the constant torque last working point of the torque-speed curve is called “Base speed point”, only if it is obtained for the maximum allowed line-line voltage and maximum line current. If it is not the case, we called as “Corner speed point”.

The following table helps to classify the test “Working point – Sine wave – Motor – T, N”.

Family	Working point
Package	Sine wave
Convention	Motor
Test	T, N

Positioning of the test “Working point – Sine wave – Motor – T, N”

2.1.2 User inputs

The main user input parameters are the mechanical torque and the targeted speed. In addition, temperatures of winding and magnets must be set.

2.1.3 Main outputs

Test results are illustrated with data, graphs and tables

2.1.3.1 Tables of results

- 1) Machine performance – Base speed point
 - General data
 - Machine constants
 - Power balance
 - Flux in airgap
 - Flux density in iron
 - Magnet behavior including evaluation of demagnetization rate
 - Maximum speed estimation

- 2) Power electronics
 - Inverter
 - Working point

- 3) Ripple mechanical torque
 - Working point

2.1.3.2 Curves

- 1) Ripple mechanical torque versus rotor angular position
- 2) Mechanical torque versus current and control angle
- 3) Flux density in airgap versus rotor angular position

2.2 Settings

Three buttons give access to the following setting definition:

- Temperature of active components: winding and magnets
- Definition of the power electronics parameters
 - Inverter control strategy
 - Inputs for evaluating the power electronics stage losses
- Definition of mechanical loss model parameters

For more details, please refer to the document: MotorFactory_SMPM_IOR_3PH_Test_Introduction – sections dealing with settings.

2.3 Inputs

2.3.1 Introduction

The total number of user inputs is equal to 11.
Among these inputs, 5 are standard inputs and 6 are advanced inputs.

2.3.2 Standard inputs

2.3.2.1 Mechanical torque

The value of the targeted “**mechanical torque**” must be provided.

2.3.2.2 Speed

The value of the targeted “**Speed**” (*Targeted speed*) must be provided.

2.3.2.3 Command mode

Two commands are available: Maximum Torque Per Voltage (MTPV) and Maximum Torque Per Amps (MTPA) command mode. For the base speed point computation, both commands lead to the same results. In fact, the base speed point corresponds to the working point which maximize the mechanical torque at maximum current and at maximum voltage. Following this, MTPA and MTPV commands give the same results on this test.

Note: The computed maximum speed depends on the chosen command mode.

2.3.2.4 Ripple torque analysis

The **“Ripple torque analysis”** (Additional analysis on ripple torque period: Yes / No) allows to compute or not to compute the value of the ripple torque and to display the corresponding torque versus the angular position over the corresponding ripple torque period. The default value is “No”.

Notes:

- This choice influences the accuracy of results and the computation time. The peak-peak ripple torque is calculated. This additional computation needs addition computation time.
- In case of “Yes”, the ripple torque is computed. Then, the flux density in regions and the magnet demagnetization rate are evaluated through the ripple torque computation.
- In case of “No”, the ripple torque is not computed. Then, the flux density in regions and the magnet demagnetization rate are evaluated by considering the Park’s model computation.

2.3.2.5 Additional losses

“Additional losses” input is not available in the current version (The input label is written in grey).

2.3.3 Advanced inputs

2.3.3.1 Number of computations for J_d , J_q

First, it is needed to compute the D-axis and Q-axis flux linkage in the J_d - J_q plane.

The process to find the working point uses a current map in J_d - J_q plane where a grid is defined.

The number of computation points along the d-axis and q-axis can be defined with the user input « **No. comp. for current J_d , J_q** » (*Number of computations for D-axis and Q-axis currents*).

The default value is equal to 5. This default value provides a good compromise between accuracy and computation time. The minimum allowed value is 5.

2.3.3.2 Number of computations per ripple torque period

The number of computations per ripple torque period is considered when the user has chosen to perform a “Ripple torque analysis” (i.e. answered “Yes” to the standard input “Ripple torque analysis”).

The user input “**No. comp. / ripple period**” (*Number of computations per ripple torque period*) influences the accuracy of results (computation of the peak-peak ripple torque) and the computation time.

The default value is equal to 30. The minimum allowed value is 25. The default value provides a good compromise between the accuracy of results and computation time.

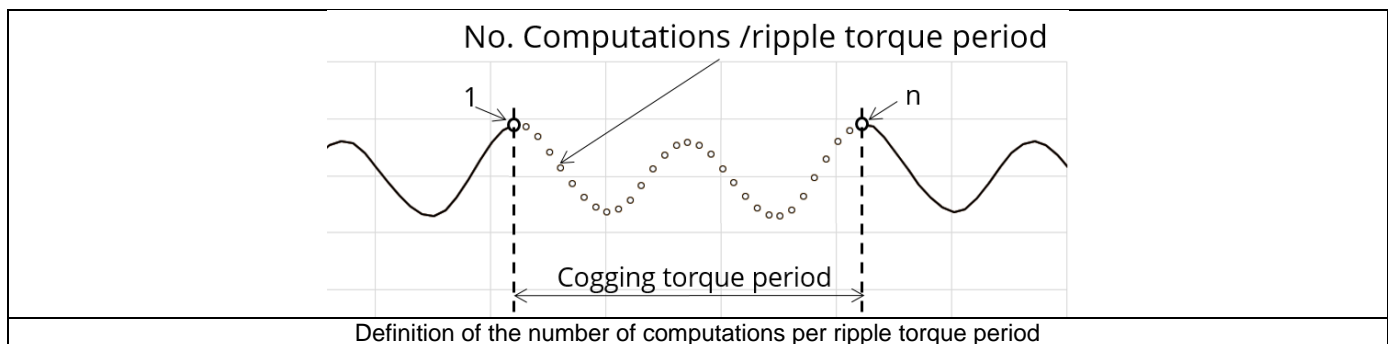

2.3.3.3 Rotor initial position

By default, the “**Rotor initial position**” is set to “**Auto**”.

When the “**Rotor initial position mode**” is set to “**Auto**”, the initial position of the rotor is automatically defined by an internal process of FluxMotor®.

The resulting relative angular position corresponds to the alignment between the axis of the stator phase 1 (reference phase) and the direct axis of the rotor north pole.

When the “**Rotor initial position**” is set to “User input” (i.e. toggle button on the right), the initial position of the rotor considered for computation must be set by the user in the field « **Rotor initial position** ». The default value is equal to 0. The range of possible values is [-360, 360].

For more details, please refer to the document: MotorFactory_SMPM_IOR_3PH_Test_Introduction – section “Rotor and stator relative position”.

2.3.3.4 Skew model – Number of layers

When the rotor magnets or the stator slots are skewed, the number of layers used in Flux® Skew environment to model the machine can be modified: “**Skew model - No. of layers**” (*Number of layers for modelling the skewing in Flux Skew environment*).

2.3.3.5 Mesh order

To get the results, the original computation is performed using a Finite Element Modeling. Two levels of meshing can be considered for this finite element calculation: first order and second order. This parameter influences the accuracy of results and the computation time.

By default, second order mesh is used.

2.3.3.6 Airgap mesh coefficient

The advanced user input “**Airgap mesh coefficient**” is a coefficient which adjusts the size of mesh elements inside the airgap. When the value of “**Airgap mesh coefficient**” decreases, the mesh elements get smaller, leading to a higher mesh density inside the airgap, increasing the computation accuracy.

The imposed Mesh Point (size of mesh elements touching points of the geometry), inside the Flux® software, is described as:

$$\text{MeshPoint} = (\text{airgap}) \times (\text{airgap mesh coefficient})$$

Airgap mesh coefficient is set to 1.5 by default. The variation range of values for this parameter is [0.05; 2]. 0.05 giving a very high mesh density and 2 giving a very coarse mesh density.

Caution:

Be aware, a very high mesh density does not always mean a better result quality. However, this always leads to a huge number of nodes in the corresponding finite element model. So, it means, a need of huge numerical memory and increases the computation time considerably.

2.4 Main principles of computations

2.4.1 Overview

The aim of this test is to give a good overview of the electromagnetic potential of the machine by characterizing the base speed point according to the targeted mechanical torque and speed set by the user. In addition, ripple torque at the base speed point is computed.

Several computation processes are involved:

- Base speed point
- Ripple torque
- Electromagnetic behavior
- Maximum speed estimation

2.4.2 Base speed point

2.4.2.1 Initialization of the computation

First, it is needed to compute the range of current to be able to reach the targeted mechanical torque.

A loop considering the values of current is done. For each value of current the maximum mechanical torque in function of the control angle is computed. When the value of the mechanical torque is very close to the targeted mechanical torque, the loop is then stopped.

The computation method used inside the loop is close than the one used for the test “Working point – Sine Wave – Motor – U-I” described in the section 3 (Working point – Sine wave – Motor –).

However, in this case, the computation of the base speed point is replaced by the computation of the maximum mechanical torque versus the control angle.

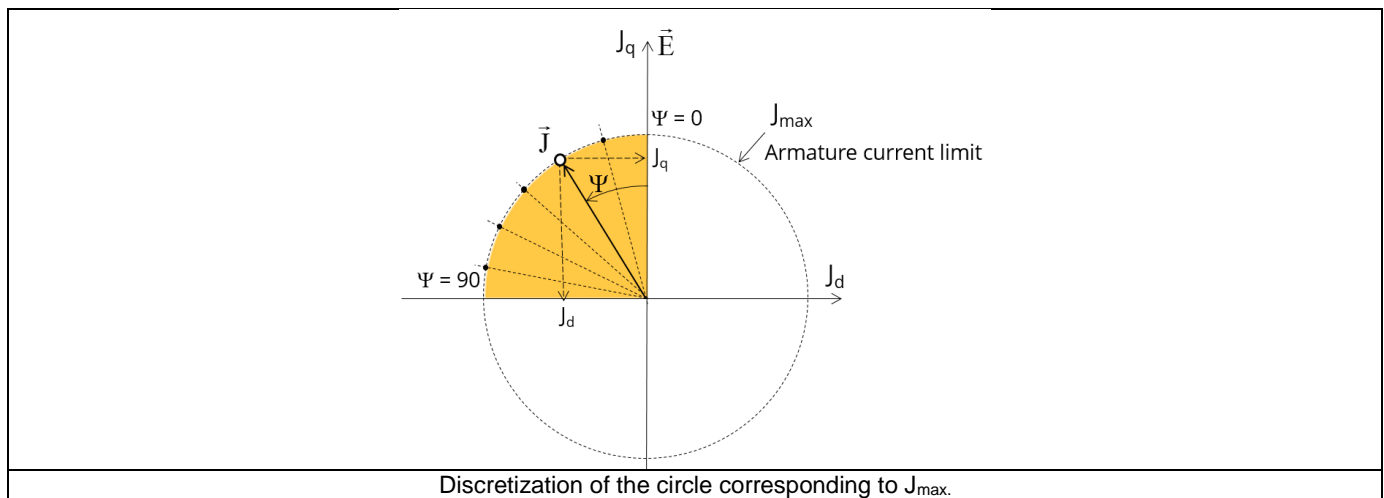

2.4.2.2 Computation of the base speed point

Thanks to the identification of the range of current in which the mechanical torque is reachable, the computation of the base speed point is done with the same computation method used for the test “Performance mapping - Sine wave - Motor – Efficiency Map”.

The computation method depends also on the chosen command.

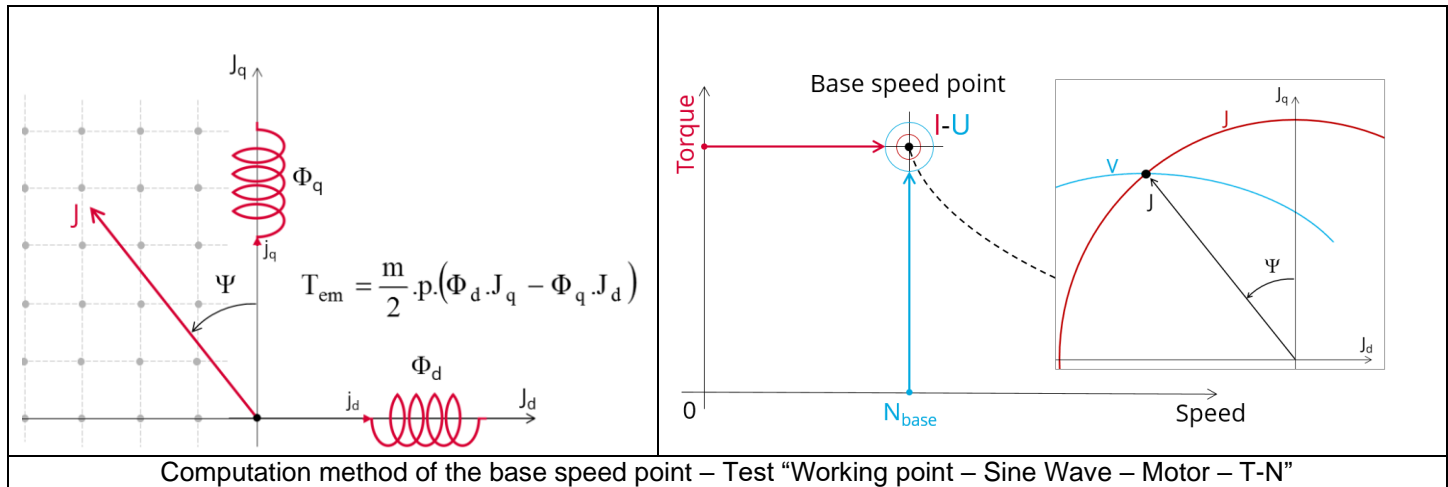

Note: We remind that for the base speed point, both commands “MTPA and MTPV” lead to the same results.

In fact, the base speed point corresponds to the working point which maximizes the mechanical torque at maximum current and at maximum voltage. Following this, we easily understand that we will obtain same results with MTPV or with MTPA.

However, the maximum speed estimation depends on whether MTPV or MTPA command mode is chosen.

2.4.3 Electromagnetic behavior

2.4.3.1 Introduction

Electromagnetic behavior computation method used depends on if ripple torque analysis is set to “Yes” or to “No”:

- “Yes” is selected: The analysis of the electromagnetic behavior is done over one ripple torque period (when torque ripple computation is not performed).
- “No” is selected: The analysis of the electromagnetic behavior is done with a dedicated static computation (1 rotor position to be considered) done for the computed working point (with line current, control angle and speed obtained for the working point).

2.4.3.2 Flux in airgap

The flux in the airgap is always computed thanks to the dedicated static computation of the working point.

The airgap flux density is computed along an airgap path in Flux® software. The resulting signal is obtained over at least an electric period. The average and the peak value of the flux density are also computed. A harmonic analysis of the flux density in airgap versus rotor position is done to compute the magnitude of the first harmonic flux density.

2.4.3.3 Flux density in iron

Mean and maximum values of each flux density in regions are computed thanks to sensors in Flux® software.

2.4.3.4 Magnet behavior

Mean values of flux density and magnetic field inside the magnets are computed thanks to sensors in Flux® software. Based on these results, demagnetization rate of the magnets is computed.

2.4.4 Ripple torque

A specific computation is performed to determine the rate of ripple torque precisely.

Considering J_d and J_q at the base speed point, a computation is performed over one ripple torque period by using Finite Element modelling (Flux® software – Magnetostatic application).

Many computation points are considered over the ripple torque period (advanced user input: **No. comp. / ripple period**).

The following steps are performed to determinate the mechanical torque.

2.4.4.1 Original computation of the electromagnetic torque

The magnetic torque exerted on a non-deformable part of the study domain is computed by the virtual work method. The torque in a given direction is obtained by deriving the system energy with respect to a virtual displacement of the part in this direction.

The magnetic torque T_{em} is given by the following derivative:

$$T_{em} = -\frac{\partial W_m}{\partial \theta}$$

$\partial \theta$ = elementary angular displacement,

W_m = magnetic energy in a volume region

The electromagnetic ripple torque is computed over the ripple torque period versus the rotor angular position $T_{em,\theta}$. The mean value “ $T_{em,mean}$ ” is computed

2.4.4.2 Mechanical ripple torque based on Park’s model

The mechanical ripple torque must be computed at the base speed.

First, we compute the electromagnetic torque “ $T_{em, Park}$ ” with Park’s model:

$$T_{em, Park} = \frac{m}{2} \times p \times (\Phi_d \times J_q - \Phi_q \times J_d)$$

Then, the iron loss torque, the mechanical loss torque and the additional loss torque are subtracted from “ $T_{em, Park}$ ” to get the corresponding mean value of the mechanical torque “ $T_{mech, Park}$ ”.

2.4.4.3 Resulting mechanical torque versus rotor angular position

To compute the resulting mechanical ripple torque, the original electromagnetic torque previously computed is weighted by the ratio of the mean value of the mechanical torque based on Park’s model ($T_{mech, Park}$) and of the mean value of the original electromagnetic ripple torque ($T_{em, mean}$).

$$T_{mech,\theta} = T_{em,\theta} \times \frac{T_{mech, Park}}{T_{em, mean}}$$

The peak-peak value of the mechanical ripple torque is then computed. The rate of ripple torque is deduced as a percentage or per unit of the nominal torque.

Warning: When the ripple torque computation is not requested, the computation of the working point is performed by considering only one position within the electrical period. It means that all the data characterizing the behavior of the machine can change based on the selection of ripple torque (Yes/No).

Flux density in magnetic circuit and the magnet behavior will be more accurately computed when the computation of the ripple torque will be requested.

2.4.5 Maximum speed estimation

The maximum speed estimation is based on obtained results at the base speed point. Thanks to Park model voltage equations (phase resistance neglected but End winding inductance considered) and computed flux linkage at the base speed point, a linear assumption is done on the flux to estimate the maximum speed. Then, a reduction factor is applied to minimize the linear assumption impact.

This computation is performed by considering the command modes (MTPV, MTPA...).

According to assumptions, the aim is just to give the order of magnitude of the reachable maximum speed of the motor.

2.5 Test results

Once a test is finished, the corresponding results are automatically displayed in the central window.

2.5.1 Test conditions

2.5.1.1 Inputs

All the parameter values, belonging to standard inputs or advanced inputs are described in this section. It shows the initial conditions considered for the test.

Here are the displayed subsections:

- Context
- Standard parameters
- Advanced parameters

For more information refer to the section 2.3 (Inputs).

2.5.1.2 Settings

All the settings dedicated to the test and dealing with the thermal are displayed in this section.

Here is the displayed subsection:

- Thermal
- Electronics
- Mechanics

2.5.1.3 Winding and magnet characteristics

All winding and magnet characteristics are displayed in the following subsections:

- Magnet characteristics
- Winding characteristics

For more details, please refer to the document: MotorFactory_SMPM_IOR_3PH_Test_Introduction – section “Machine characteristics”.

2.5.2 Main results

2.5.2.1 Machine performance – Working point

Output data displayed in the following subsections are described in section Working point – Sine wave – Motor.

Here are the displayed subsections:

- General data
- Machine constants
- Power balance
- Flux in airgap
- Flux density in iron
- Magnet behavior

2.5.2.2 Power electronics

- Inverter

When power electronics stage is selected by the user, the inverter control strategy and the DC bus voltage are reminded. For information, the corresponding maximum line-line voltage, rms value is computed and displayed.

- Working point

The power balance and the corresponding efficiencies are computed and displayed for the machine, the power electronics stage and for the system (i.e. machine + power electronics stage).

For more details, please refer to the document: MotorFactory_SMPM_IOR_3PH_Test_Introduction – sections dealing with “Working point – Sine wave – Display of results”.

2.5.2.3 Ripple mechanical torque

The analysis of the ripple torque is presented in the table “Ripple mechanical torque” with the following subsections:

- Working point

For more details, please refer to the document: MotorFactory_SMPM_IOR_3PH_Test_Introduction – sections dealing with “Working point – Sine wave – Display of results”.

2.5.3 Curves

- Ripple mechanical torque versus rotor angular position
- Mechanical torque versus current and control angle
- Flux density in airgap versus rotor angular position

3 WORKING POINT – SINE WAVE – MOTOR – I, U

3.1 Overview,

3.1.1 Positioning and objective

The aim of the test “**Working point – Sine wave – Motor – I, U**” is to characterize the behavior of the machine when operating at the working point which is targeted by the user. It corresponds to the base point at the imposed maximum line current and maximum Line-Line voltage.

The base point of the torque-speed curve is defined by considering the targeted input values I, U (Voltage, current). Then, this test allows deducing the performance for this working point.

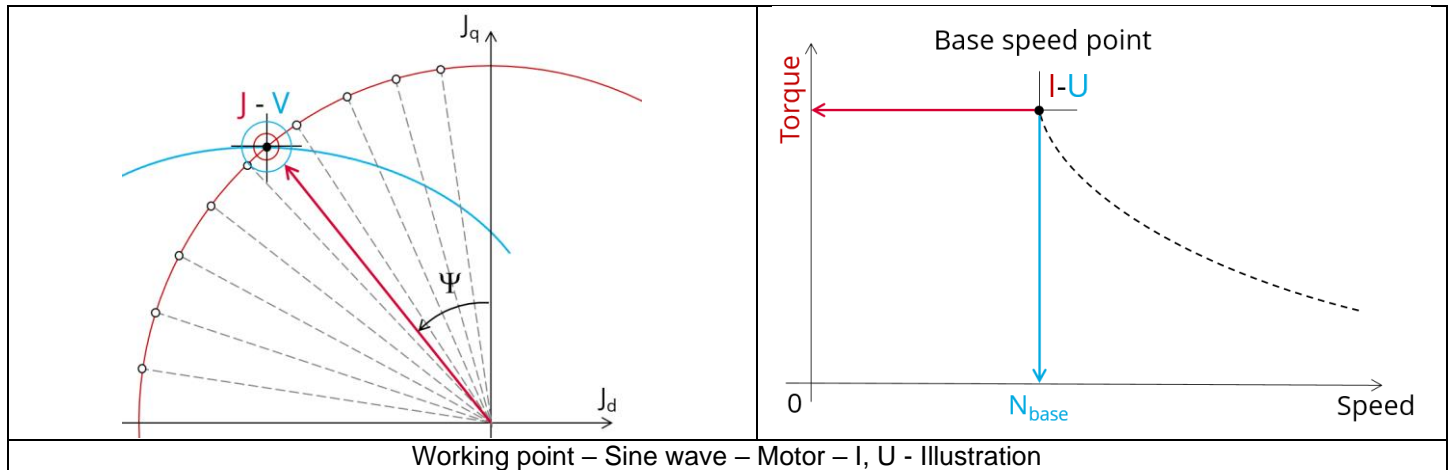

The results of this test give an overview of the electromagnetic analysis of the motor considering the machine topology. The general data of the machine, like machine constants, power balance and magnet behavior are computed and displayed. The magnetic flux density is also computed in every region of the machine’s magnetic circuit to evaluate the design. In addition, ripple torque at the base speed point is computed.

The following table helps to classify the test “Working point – Sine wave – Motor – I, U”.

Family	Working point
Package	Sine wave
Convention	Motor
Test	I, U

Positioning of the test “Working point – Sine wave – Motor – I, U”

3.1.2 User inputs

The main user input parameters are the maximum allowed supplied Line-Line voltage and line current. In addition, temperatures of winding and magnets must be set.

3.1.3 Main outputs

Test results are illustrated with data, graphs, and tables

3.1.3.1 Tables of results

- 1) Machine performance – Base speed point
 - General data
 - Machine constants
 - Power balance
 - Flux in airgap
 - Flux density in iron
 - Magnet behavior including evaluation of demagnetization rate
 - Maximum speed estimation

- 2) Power electronics
 - Inverter
 - Working point

- 3) Ripple mechanical torque
 - Working point

3.1.3.2 Curves

- 1) Ripple mechanical torque versus rotor angular position
- 2) Mechanical torque versus current and control angle
- 3) Flux density in airgap versus rotor angular position

3.2 Settings

Three buttons give access to the following setting definition:

- Temperature of active components: winding and magnets
- Definition of the power electronics parameters
 - Inverter control strategy
 - DC bus voltage before inverter stage
 - Inputs for evaluating the power electronics stage losses
- Definition of mechanical loss model parameters

For more details, please refer to the document: [MotorFactory_SMPM_IOR_3PH_Test_Introduction](#) – sections dealing with settings.

3.3 Inputs

3.3.1 Introduction

The total number of user inputs is equal to 13. Among these inputs, 7 are standard inputs and 6 are advanced inputs.

3.3.2 Standard inputs

3.3.2.1 Current definition mode

There are 2 common ways to define the electrical current.

Electrical current can be defined by the current density in electric conductors. In this case, the current definition mode should be « **Density** ».

Electrical current can be defined directly by indicating the value of the line current (the rms value is required). In this case, the current definition mode should be « **Current** ».

3.3.2.2 Maximum line current, rms

When the choice of current definition mode is “**Current**”, the rms value of the maximum line current supplied to the machine: “**Max. line current, rms**” (*Maximum line current, rms value*) must be provided.

Note: The number of parallel paths and the winding connection are automatically considered in the results.

3.3.2.3 Maximum current density, rms

When the choice of current definition mode is “**Density**”, the rms value of the maximum current density in electric conductors “**Max. current dens., rms**” (*Maximum current density in conductors, rms value*) must be provided.

Note: The number of parallel paths and the winding connection are automatically considered in the results.

3.3.2.4 Command mode

Two commands are available: Maximum Torque Per Voltage (MTPV) and Maximum Torque Per Amps (MTPA) command mode. For the base speed point computation, both commands lead to the same results. In fact, the base speed point corresponds to the working point which maximize the mechanical torque at maximum current and at maximum voltage. Following this, MTPA and MTPV commands give the same results on this test.

Note: The computed maximum speed depends on the chosen command mode.

3.3.2.5 Ripple torque analysis

The “**Ripple torque analysis**” (Additional analysis on ripple torque period: Yes / No) allows to compute or not to compute the value of the ripple torque and to display the corresponding torque versus the angular position over the corresponding ripple torque period. The default value is “No”.

Notes:

- This choice influences the accuracy of results and on the computation time. The peak-peak ripple torque is calculated. This additional computation needs addition computation time.
- In case of “Yes”, the ripple torque is computed. Then, the flux density in regions and the magnet demagnetization rate are evaluated through the ripple torque computation.
- In case of “No”, the ripple torque is not computed. Then, the flux density in regions and the magnet demagnetization rate are evaluated by considering the Park’s model computation.

3.3.2.6 Additional losses

“Additional losses” input is not available in the current version (The input label is written in grey).

3.3.3 Advanced inputs

3.3.3.1 Number of computations for control angle

Considering the vector diagram shown below, the control angle Ψ is the angle between the electromotive force E and the electrical current J ($\Psi = (E, J)$).

The computation to get the corner point location is performed by considering control angle (Ψ) over a range of 0 to 90 electrical degrees. The user input “**No. comp. for ctrl. angle**” (*Number of computations for the control angle*) allows to choose between accuracy of results and computation time by using a number of computations between $\psi = 0^\circ$ and $\psi = 90^\circ$. The variation area for ψ is represented by the quarter circle (colored yellow in the diagram). This discretization is necessary to find the working point corresponding to the base speed point of the torque-speed curve.

The default value of Number of computations for the control angle is equal to 5. The minimum allowed value is 5.

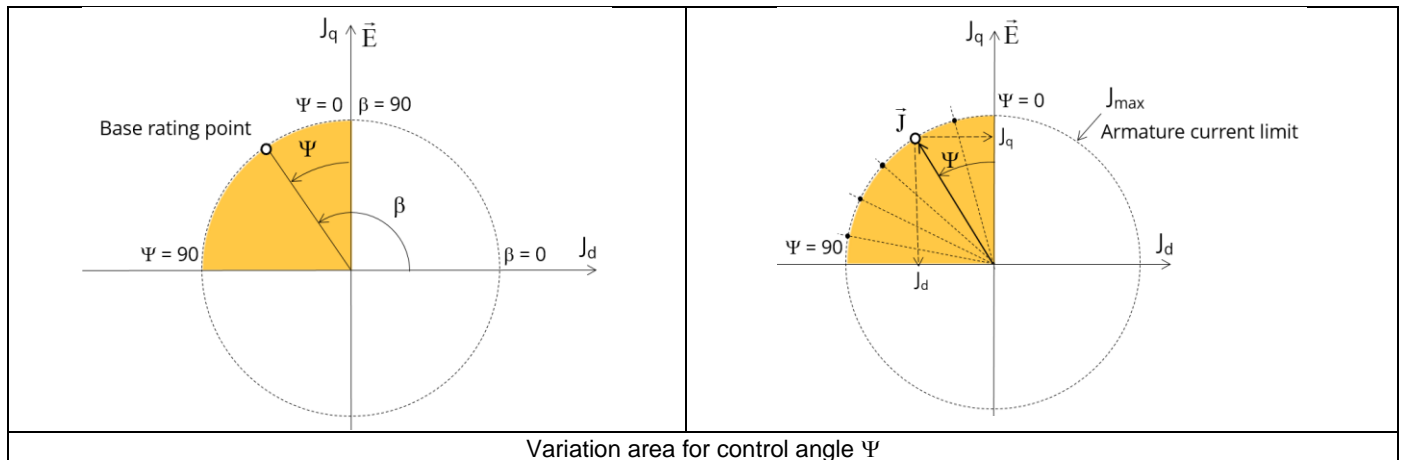

3.3.3.2 Number of computations per ripple torque period

The number of computations per ripple torque period is considered when the user chooses to perform a “Ripple torque analysis” (i.e. answered “Yes” to the standard input “Ripple torque analysis”).

The user input “**No. comp. / ripple period**” (*Number of computations per ripple torque period*) influences the accuracy of results (computation of the peak-peak ripple torque) and the computation time.

The default value is equal to 30. The minimum allowed value is 25. The default value provides a good compromise between the accuracy of results and computation time.

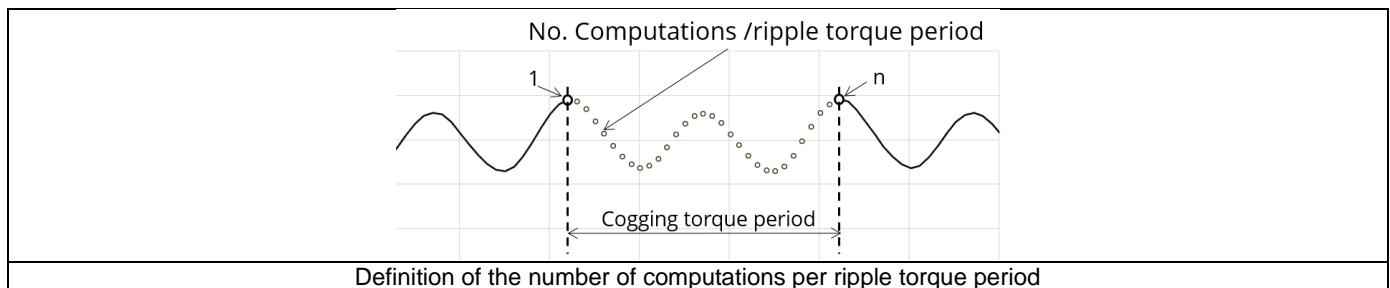

3.3.3.3 Rotor initial position

By default, the “**Rotor initial position**” is set to “**Auto**”.

When the “**Rotor initial position mode**” is set to “**Auto**”, the initial position of the rotor is automatically defined by an internal process of FluxMotor®.

The resulting relative angular position corresponds to the alignment between the axis of the stator phase 1 (reference phase) and the direct axis of the rotor north pole.

When the “**Rotor initial position**” is set to “User input” (i.e. toggle button on the right), the initial position of the rotor considered for computation must be set by the user in the field « **Rotor initial position** ». The default value is equal to 0. The range of possible values is $[-360, 360]$.

For more details, please refer to the document: MotorFactory_SMPM_IOR_3PH_Test_Introduction – section “Rotor and stator relative position”.

3.3.3.4 Skew model – Number of layers

When the rotor magnets or the stator slots are skewed, the number of layers used in Flux® Skew environment to model the machine can be modified: “**Skew model - No. of layers**” (*Number of layers for modelling the skewing in Flux® Skew environment*).

3.3.3.5 Mesh order

To get the results, the original computation is performed using a Finite Element Modeling.

Two levels of meshing can be considered for this finite element calculation: first order and second order.

This parameter influences the accuracy of results and the computation time.

By default, second order mesh is used.

3.3.3.6 Airgap mesh coefficient

The advanced user input “**Airgap mesh coefficient**” is a coefficient which adjusts the size of mesh elements inside the airgap. When the value of “Airgap mesh coefficient” decreases, the mesh elements get smaller, leading to a higher mesh density inside the airgap, increasing the computation accuracy.

The imposed Mesh Point (size of mesh elements touching points of the geometry), inside the Flux® software, is described as:

$$\text{MeshPoint} = (\text{airgap}) \times (\text{airgap mesh coefficient})$$

Airgap mesh coefficient is set to 1.5 by default.

The variation range of values for this parameter is [0.05; 2].

0.05 giving a very high mesh density and 2 giving a very coarse mesh density.

Caution:

Be aware, a very high mesh density does not always mean a better result quality. However, this always leads to a huge number of nodes in the corresponding finite element model. So, it means a need of huge numerical memory and increases the computation time considerably.

3.4 Main principles of computation

3.4.1 Introduction

The aim of this test is to give a good overview of the electromagnetic potential of the machine by characterizing the base speed point according to the maximum Line-Line voltage and the maximum line current set by the user. In addition, ripple torque at the base speed point is computed.

For this purpose, several computation processes are involved:

- Base speed point
- Electromagnetic behavior
- Ripple torque
- Maximum speed estimation

3.4.2 Base speed point

The base speed point of the torque speed curve corresponds to the obtained working point by considering the maximum allowed values of line current and line-line voltage (I_{max} and U_{max}).

The quarter of circle corresponding to the maximum phase current in the J_d - J_q plane is discretized by considering the number of computations for control angle (Ψ) which is a user input parameter.

Several quantities, like the flux in the coils and flux density in regions (teeth and yoke to be able to compute iron losses) are computed as a function of the control angle Ψ .

These computations are done by using Finite Element Modelling (Flux® software – Magnetostatic application).

- $\Phi_d = f(\Psi)$
- $\Phi_q = f(\Psi)$
- $B = f(\Psi)$

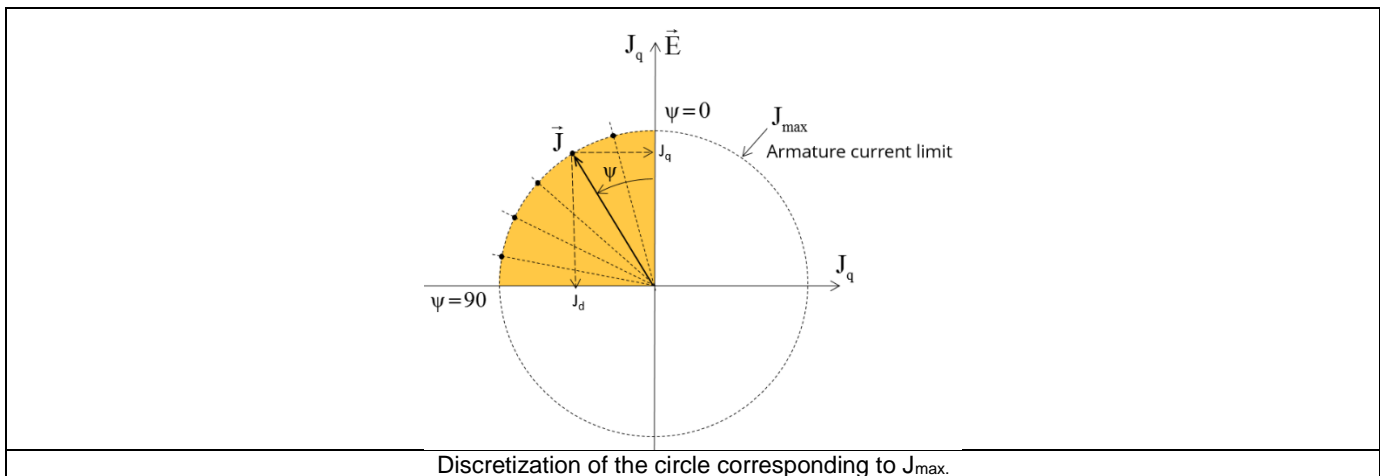

Then an optimization process is performed to get the base speed point which corresponds to the working point at maximum line current and maximum line-line voltage: $I = I_{max}$ and $U = U_{max}$.

The resulting data are called “general data” and include:

- The control angle (Ψ) and thereby J_d and J_q
- The base speed
- The electrical frequency
- The torque
- The voltage components (V_d , V_q)
-

In addition, the power balance is done and machine constant for the base speed point “kT” is computed.

For more details, please refer to the document: MotorFactory_SMPM_IOR_3PH_Test_Introduction – section dealing with “Electrical machine – Theoretical equations”.

3.4.3 Electromagnetic behavior

3.4.3.1 Introduction

Used method of electromagnetic behavior computation depends on if ripple torque analysis is set to “Yes” or to “No”:

- “Yes” is selected: The analysis of the electromagnetic behavior is done over one ripple torque period (when torque ripple computation is not performed).
- “No” is selected: The analysis of the electromagnetic behavior is done with a dedicated static computation (1 rotor position to be considered) done for the working point computed (with line current, control angle and speed obtained for the working point).

3.4.3.2 Flux in airgap

The flux in the airgap is always computed thanks to the dedicated static computation of the working point.

The airgap flux density is computed along a path in the airgap in Flux® software. The resulting signal is obtained over at least an electric period. The average and the peak value of the flux density are also computed. A harmonic analysis of the flux density in airgap versus rotor position is done to compute the magnitude of the first harmonic of the flux density.

3.4.3.3 Flux density in iron

Mean and maximum values of flux density of each iron region are computed thanks to sensors in Flux® software.

3.4.3.4 Magnet behavior

Mean values of flux density and magnetic field inside the magnets are computed thanks to sensors in Flux® software. Based on these results, demagnetization rate of the magnets is computed.

3.4.4 Ripple torque

A specific computation is performed to determine the rate of ripple torque precisely.

Considering J_d and J_q at the base speed point, a computation is performed over one ripple torque period by using Finite Element modelling (Flux® software – Magnetostatic application).

Many computation points are considered over the ripple torque period (advanced user input: **No. comp. / ripple period**).

The following steps are performed to determinate the mechanical torque.

3.4.4.1 Original computation of the electromagnetic torque

The magnetic torque exerted on a non-deformable part of the study domain is computed by the virtual work method. The torque in a given direction is obtained by deriving the system energy with respect to a virtual displacement of the part in this direction.

The magnetic torque T_{em} is given by the following derivative:

$$T_{em} = - \frac{\partial W_m}{\partial \theta}$$

$\partial \theta$ = elementary angular displacement,

W_m = magnetic energy in a volume region

The electromagnetic ripple torque is computed over the ripple torque period versus the rotor angular position $T_{em,\theta}$. The mean value “ $T_{em,mean}$ ” is computed

3.4.4.2 Mechanical ripple torque based on Park’s model

The mechanical ripple torque must be computed at the base speed.

First, we compute the electromagnetic torque “ $T_{em, Park}$ ” with Park’s model:

$$T_{em, Park} = \frac{m}{2} \times p \times (\Phi_d \times J_q - \Phi_q \times J_d)$$

Then, the iron loss torque, the mechanical loss torque and the additional loss torque are subtracted from “ $T_{em, Park}$ ” to get the corresponding mean value of the mechanical torque “ $T_{mech, Park}$ ”.

3.4.4.3 Resulting mechanical torque versus rotor angular position

To compute the resulting mechanical ripple torque, the original electromagnetic torque previously computed is weighted by the ratio of the mean value of the mechanical torque based on Park's model ($T_{\text{mech, Park}}$) and of the mean value of the original electromagnetic ripple torque ($T_{\text{em, mean}}$).

$$T_{\text{mech},\theta} = T_{\text{em},\theta} \times \frac{T_{\text{mech, Park}}}{T_{\text{em, mean}}}$$

The peak-peak value of the mechanical ripple torque is then computed. The rate of ripple torque is deduced as a percentage or per unit of the nominal torque.

Warning: When the ripple torque computation is not requested, the computation of the working point is performed by considering only one position within the electrical period. It means that all the data characterizing the behavior of the machine can change based on the selection of ripple torque (Yes/No).

Flux density in magnetic circuit and the magnet behavior will be more accurately computed when the computation of the ripple torque will be requested.

3.4.5 Maximum speed estimation

The maximum speed estimation is based on results obtain at the base speed point. Thanks to Park model voltage equations (phase resistance neglected but End winding inductance considered) and flux linkage computed at the base speed point, a linear assumption is done on the flux to estimate the maximum speed. Then, a reduction factor is applied to minimize the linear assumption impact. This computation is performed by considering the command mode (MTPV, MTPA...).

According to assumptions, the aim is just to give the order of magnitude of the maximum speed reachable by the motor.

3.5 Test results

Once a test is finished, the corresponding results are automatically displayed in the central window.

3.5.1 Test conditions

3.5.1.1 Inputs

All the parameter values, belonging to standard inputs or advanced inputs are described in this section. It shows the initial conditions considered for the test.

Here are the displayed subsections:

- Context
- Standard parameters
- Advanced parameters

For more information refer to the section 3.3 (Inputs).

3.5.1.2 Settings

All the settings dedicated to the test and dealing with the thermal are displayed in this section.

Here is the displayed subsection:

- Thermal
- Electronics
- Mechanics

For more details, please refer to the document: MotorFactory_SMPM_IOR_3PH_Test_Introduction – sections dealing with settings.

3.5.1.3 Winding and magnet characteristics

All winding and magnet characteristics are displayed in the following subsections:

- Magnet characteristics
- Winding characteristics

For more details, please refer to the document: MotorFactory_SMPM_IOR_3PH_Test_Introduction – section “Machine characteristics”.

3.5.2 Main results

3.5.2.1 Machine performance – Working point

Output data displayed in the following subsections are described in section Working point – Sine wave –Motor.

Here are the displayed subsections:

- General data
- Machine constants
- Power balance
- Flux in airgap
- Flux density in iron
- Magnet behavior
- Maximum speed estimation

3.5.2.2 Power electronics

- Inverter

When power electronics stage is selected by the user, the inverter control strategy and the DC bus voltage are reminded. For information, the corresponding maximum line-line voltage, rms value is computed and displayed.

- Working point

The power balance and the corresponding efficiencies are computed and displayed for the machine, the power electronics stage and for the system (i.e. machine + power electronics stage).

For more details, please refer to the document: MotorFactory_SMPM_IOR_3PH_Test_Introduction – sections dealing with “Power electronics mode settings”.

3.5.2.3 Ripple mechanical torque

The analysis of the ripple torque is presented in the table “Ripple mechanical torque” with the following subsections:

- Working point

For more details, please refer to the document: MotorFactory_SMPM_IOR_3PH_Test_Introduction – sections dealing with “Working point – Sine wave – Display of results”.

3.5.3 Curves

- Ripple mechanical torque versus rotor angular position
- Mechanical torque versus current and control angle
- Flux density in airgap versus rotor angular position

4 WORKING POINT – SINE WAVE – GENERATOR – I, Ψ , N

4.1 Overview

4.1.1 Positioning and objective

The aim of the test “**Working point – Sine wave – Generator – I, Ψ , N**” is to characterize the behavior of the machine when operating at the targeted input values I, Ψ , N (Magnitude of current, Control angle, Speed). These three inputs are enough to impose a precise working point.

For instance, a working point on the efficiency map can be chosen, by identifying the current, the control angle and the speed with different curves or maps displayed in the “Performance mapping / Sine wave / Generator / Efficiency map” test. Then, the “Working point – Sine wave – Generator – I, Ψ , N” test allows to compute the performance for this working point.

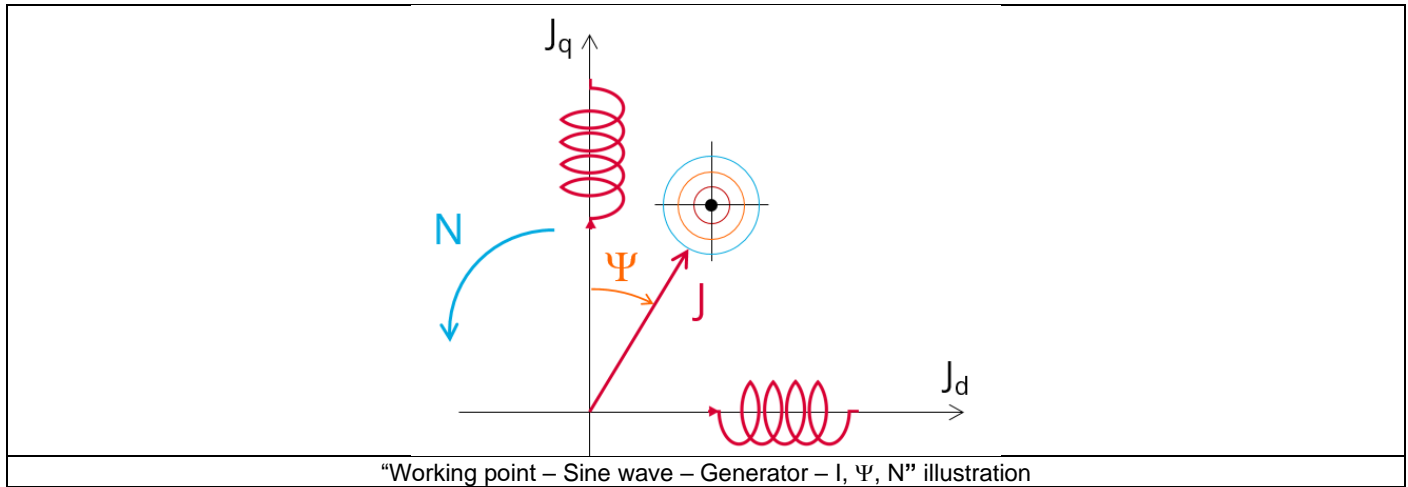

The results of this test give an overview of the electromagnetic analysis of the machine considering its topology. The general data of the machine, like machine constants, power balance and magnet behavior are computed and displayed. The generator convention is used to build the model. The magnetic flux density is also computed in every region of the machine magnetic circuit to evaluate the design.

When both the following conditions are met this test allows to perform electromagnetic computations with coupled thermal analysis.:

- The type of machine is Synchronous Machine with Permanent Magnets with Inner rotor.
- One of the two following thermal solving modes is selected: One iteration or iterative solving mode.

Two computation modes are available:

- “Fast computation mode” is perfectly suited for the pre-design step (Hybrid model based on Magneto-Static Finite Element computations and Park transformation theory)
- “Accurate computation mode” is perfectly suited for the final design step (Pure Finite Element modeling based on transient computations)

It also gives the capability to make comparisons between the results obtained from the measurements and those obtained with FluxMotor®.

The following table helps to classify the test “Working point – Sine wave – Generator – I, Ψ , N”.

Family	Working point
Package	Sine wave
Convention	Generator
Test	I, Ψ , N

Positioning of the test “Working point – Sine wave – Generator – I, Ψ , N”

4.1.2 User inputs

The four main user input parameters are the supply line current, control angle, speed, and the computation mode. In addition, temperatures of winding and magnets must be set.

4.1.3 Main outputs

Test results are illustrated with data, graphs, and tables.

4.1.3.1 Tables of results

- 1) Machine performance – Base speed point
 - General data
 - Machine constants
 - Power balance
 - Flux in airgap
 - Flux density in iron
 - Magnet behavior including evaluation of demagnetization rate
- 2) Power electronics
 - Inverter
 - Working point
- 3) Ripple mechanical torque
 - Working point
- 4) Thermal data
 - Table of temperatures

4.1.3.2 Curves – in the “Fast computation modes”

- 1) Ripple mechanical torque versus rotor angular position
- 2) Flux density in airgap versus rotor angular position
- 3) Chart of temperature (radial and axial views)

4.1.3.3 Curves – in the “Accurate computation modes”

- 1) Mechanical torque versus rotor angular position
- 2) Mechanical torque harmonic analysis
- 3) Flux density in airgap versus rotor angular position
- 4) Flux density in airgap harmonic analysis
- 5) Phase voltage versus rotor angular position
- 6) Phase voltage harmonic analysis
- 7) Phase current versus rotor angular position
- 8) Phase current harmonic analysis

4.1.3.4 Graphics

- 1) Isovalues

4.1.3.5 Temperatures

- 1) Chart of temperature (radial and axial views)
- 2) Thermal data
 - Table of temperatures

4.2 Settings

Two buttons give access to the following setting definition: Thermal and Mechanics. Each kind of settings is briefly defined here. For more details, please refer to the document: MotorFactory_SMPM_IOR_3PH_Test_Introduction – sections dealing with settings.

4.2.1 Thermal settings

In the thermal settings you have two main possible choices:

- Either you can define the temperatures of active components (Magnet and winding) to define the physical properties of the materials needed to run directly the test without any thermal computation.
- Or you can choose between two other ways to run the test: iterative process until convergence or a single iteration process to perform electromagnetic computation coupled to thermal analysis.

1	Dialog box to define the thermal settings. Buttons allow to choose one of the three thermal solving modes
2	The first option of thermal setting is to run the test with only electromagnetic computation without any thermal analysis. This option is the default one available for all the tests.
2a	Dialog box that allows to define the machine active components winding and magnets temperatures to run test without any thermal analysis.
2b	Temperatures of the machine active components to be considered for characterizing the physical properties of the associated materials.
3	Thermal solving mode with only one iteration between electromagnetic and thermal computations.
4	Thermal solving mode with iterative process between electromagnetic and thermal computations till the convergence.
5	Initial temperatures of the machine active components winding and magnets. These temperatures are used to initialize the electromagnetic-thermal process of computation
6	Definition of coolant temperatures to be considered: <ul style="list-style-type: none"> • External fluid temperature ⁽¹⁾ • Cooling circuit fluid inlet temperature (when a cooling circuit is defined on the design side ⁽²⁾)

Notes

(1): The external fluid temperature corresponds to the temperature of the fluid surrounding the machine. It is also considered as the temperature at the “infinite” for the computation of radiation from the frame to the “infinite”.

(2): The cooling circuit fluid temperature is relevant only when a cooling circuit has been added by the user in the design environment. In this case, this input describes its fluid inlet temperature.

For more details, please refer to the document: MotorFactory_SMPM_IOR_3PH_Test_Introduction – section “thermal settings”.

4.2.2 Mechanical loss model parameters

A dialog box allows defining the mechanical loss computation model.

For more details, please refer to the document: MotorFactory_SMPM_IOR_3PH_Test_Introduction – section “Mechanical loss model settings”.

4.3 Inputs

4.3.1 Introduction

The total number of user inputs is equal to 13.

Among these inputs, 7 are standard inputs and 6 are advanced inputs.

4.3.2 Standard inputs

4.3.2.1 Computation modes

There are 2 modes of computation.

The “**Fast**” computation mode is the default one. It corresponds to a hybrid model which is perfectly suited for the pre-design step. Indeed, all the computations in the back end are based on magnetostatic finite element computations associated to Park transformation. It evaluates the electromagnetic quantities with the best compromise between accuracy and computation time to explore the space of solutions quickly and easily.

The “**Accurate**” computation mode allows solving the computation with transient magnetic finite element modelling. This mode of computation is perfectly suited to the final design step because it allows getting more accurate results. It also computes additional quantities like the AC losses in winding, rotor iron losses and Joule losses in magnets.

4.3.2.2 Current definition mode

There are 2 common ways to define the electrical current.

Electrical current can be defined by the current density in electric conductors.

In this case, the current definition mode should be « **Density** ».

Electrical current can be defined directly by indicating the value of the line current (the rms value is required).

In this case, the current definition mode should be « **Current** ».

4.3.2.3 Line current, rms

When the choice of current definition mode is “**Current**”, the rms value of the line current supplied to the machine: “**Line current, rms**” (*Line current, rms value*) must be provided.

4.3.2.4 Current density, rms

When the choice of current definition mode is “**Density**”, the rms value of the current density in electric conductors “**Current density, rms**” (*Current density in conductors, rms value*) must be provided.

Note: The number of parallel paths and the winding connection are automatically considered in the results.

4.3.2.5 Control angle

Considering the vector diagram shown below, the “**Control angle**” is the angle between the electromotive force \vec{E} and the electrical current (J) i.e. ($\Psi = (\vec{E}, J)$).

The default value is 45 degrees. It is an electrical angle. It must be set in a range of -180 to 180 degrees.

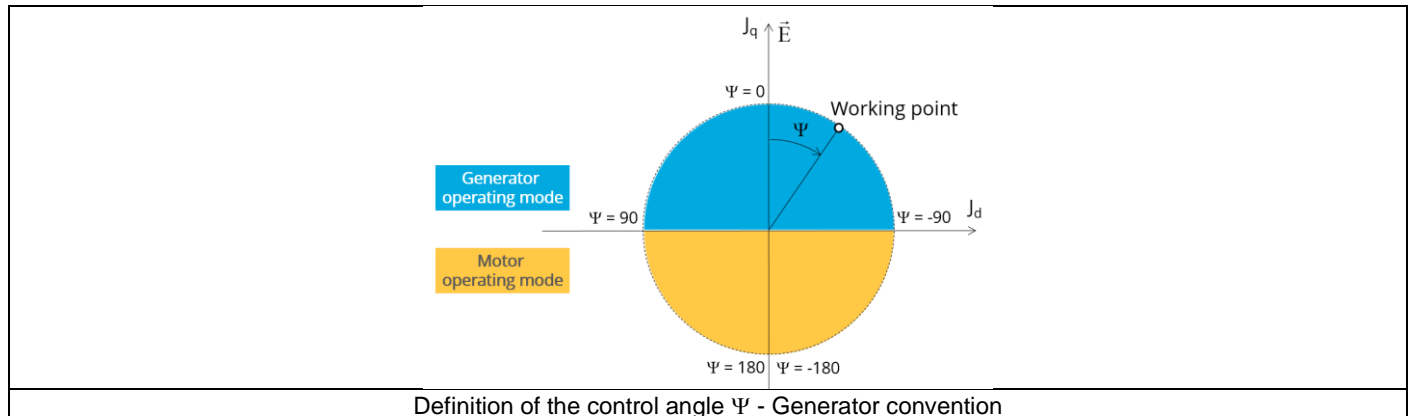

4.3.2.6 AC losses analysis

The “**AC losses analysis**” (AC losses analysis required only while “Accurate” computation mode is selected) allows computing or not AC losses in stator winding. There are three available options:

None: AC losses are not computed. However, as the computation mode is “Accurate”, a transient computation is performed without representing the solid conductors (wires) inside the slots. Phases are modeled with coil regions. Thus, the mesh density (number of nodes) is lower which leads to a lower computation time.

FE-One phase: AC losses are computed with only one phase modeled with solid conductors (wires) inside the slots. The other two phases are modeled with coil regions. Thus, AC losses in winding are computed with a lower computation time than if all the phases were modeled with solid conductors. However, this can have a little impact on the accuracy of results because we have supposed that the magnetic field is not impacted by the modeling assumption.

FE-All phase: AC losses are computed, with all phases modeled with solid conductors (wires) inside the slots. This computation method gives the best results in terms of accuracy, but with a higher computation time.

FE-Hybrid: AC losses in winding are computed without representing the wires (strands, solid conductors) inside the slots.

Since the location of each wire is accurately defined in the winding environment, sensors evaluate the evolution of the flux density close each wire. Then, a postprocessing based on analytical approaches computes the resulting current density inside the conductors and the corresponding Joule losses.

The wire topology can be “Circular” or “Rectangular”.

There can be one or several wires in parallel (in hand) in a conductor (per turn).

This method leads to quite accurate results with lower computation time. This is a good compromise between accuracy and computation time.

Warning: With the “FE-Hybrid” option the accuracy of results is good especially when the wire size is small (let’s say wire diameter lower than 2.5 mm). However, this can have a little impact on the accuracy of results because we have supposed that the magnetic field is not impacted by the modeling assumption.

Note: With FE-Hybrid option the recommended “Number of computed electrical periods” is equal to “1/2” whereas 2 computed electrical periods are needed for “FE-One phase” and for “FE-All phase” options.

Indeed, when solid conductors are represented in the Finite Element model (like with FE-One phase and FE-All phase options), there are transient phenomena to consider which leads to increase the “Number of computed electrical periods” to reach the steady state.

With the “FE-Hybrid option”, the transient phenomena are handled by the analytical model, so, it is not necessary to increase the “Number of computed electrical periods” compared to a study with “None” options (without AC losses computation).

Note: When the winding is built with a hairpin technology the FE-Hybrid mode is not available because it is not relevant for computations with such kind of winding/conductors.

4.3.2.7 Speed

The imposed “**Speed**” (*Speed*) of the machine must be set.

4.3.2.8 Ripple torque analysis

The “**Ripple torque analysis**” (Additional analysis on ripple torque period: Yes / No) allows to compute or not to compute the value of the ripple torque and to display the corresponding torque versus the angular position over the ripple torque period. The default value is “No”.

Notes:

- This choice influences the accuracy of results and the computation time. The peak-peak ripple torque is calculated. This additional computation needs addition computation time.
- In case of “**Yes**”, the ripple torque is computed. Then, the flux density in regions and the magnet demagnetization rate are evaluated through the ripple torque computation.
- In case of “**No**”, the ripple torque is not computed. Then, the flux density in regions and the magnet demagnetization rate are evaluated by considering the Park’s model computation.

4.3.2.9 Additional losses

“Additional losses” input is not available in the current version (The input label is written in grey).

4.3.3 Advanced inputs

4.3.3.1 Number of computed electrical periods

The user input “**No. computed elec. periods**” (Number of computed electrical periods only required with “Accurate” computation mode) influences the accuracy of results especially in case of AC losses computation. Indeed, with represented conductors (AC losses analysis set to “FE - One phase” or “FE - All phase”) the computation may lead to have transient current evolution in wires requiring more than an electrical period of simulation to reach the steady state over an electrical period.

The default value is equal to 2. The minimum allowed value is 0.5 (recommended with AC losses analysis set to “None”). The default value provides a good compromise between the accuracy of results and computation time.

4.3.3.2 Number of points per electrical period

The user input “**No. points / electrical period**” (Number of points per electrical period required only with “Accurate” computation mode) influences the accuracy of results (computation of the peak-peak ripple torque, iron losses, AC losses...) and the computation time.

The default value is equal to 40. The minimum recommended value is 20. The default value provides a good balance between accuracy of results and the computation time.

4.3.3.3 Number of computations per ripple torque period

The number of computations per ripple torque period is considered when the user has chosen to perform a “Ripple torque analysis” (i.e. answered “Yes” to the standard input “Ripple torque analysis” required only with “Fast” computation mode).

The user input “**No. comp. / ripple period**” (Number of computations per ripple torque period) influences the accuracy of results (computation of the peak-peak ripple torque) and the computation time.

The default value is equal to 30. The minimum allowed value is 25. The default value provides a good balance between the accuracy of results and computation time.

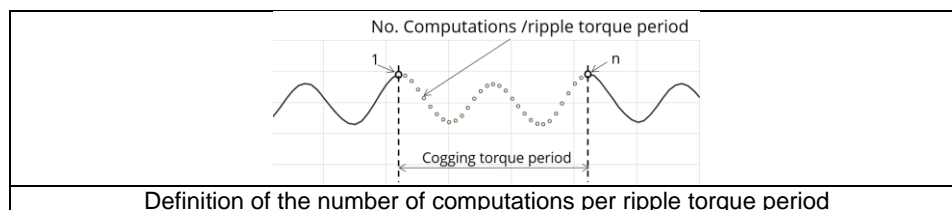

4.3.3.4 Rotor initial position

By default, the “**Rotor initial position**” is set to “**Auto**”.

When the “**Rotor initial position mode**” is set to “**Auto**”, the initial position of the rotor is automatically defined by an internal process of FluxMotor®. The resulting relative angular position corresponds to the alignment between the axis of the stator phase 1 (reference phase) and the direct axis of the rotor north pole.

When the “**Rotor initial position**” is set to “User input” (i.e., toggle button on the right), the initial position of the rotor considered for computation must be set by the user in the field « **Rotor initial position** ». The default value is equal to 0. The range of possible values is [-360, 360].

For more details, please refer to the document: MotorFactory_SMPM_IOR_3PH_Test_Introduction – section “Rotor and stator relative position”.

4.3.3.5 Skew model – Number of layers

When the rotor magnets or the stator slots are skewed, the number of layers used in Flux® Skew environment to model the machine can be modified: “**Skew model - No. of layers**” (*Number of layers for modelling the skewing in Flux® Skew environment*).

4.3.3.6 Mesh order

To get the results, the original computation is performed using a Finite Element Modeling.

Two levels of meshing can be considered for this finite element calculation: first order and second order.

This parameter influences the accuracy of results and the computation time.

By default, second order mesh is used.

4.3.3.7 Airgap mesh coefficient

The advanced user input “**Airgap mesh coefficient**” is a coefficient which adjusts the size of mesh elements inside the airgap. When the value of “Airgap mesh coefficient” decreases, the mesh elements get smaller, leading to a higher mesh density inside the airgap, increasing the computation accuracy.

The imposed Mesh Point (size of mesh elements touching the points of the geometry), inside the Flux® software, is described as:

$$\text{MeshPoint} = (\text{airgap}) \times (\text{airgap mesh coefficient})$$

Airgap mesh coefficient is set to 1.5 by default.

The variation range of values for this parameter is [0.05; 2].

0.05 gives a very high mesh density and 2 gives a very coarse mesh density.

Caution:

Be aware, a very high mesh density does not always mean a better result quality. However, this always leads to a formation of a huge number of nodes in the corresponding finite element model. So, it means a need of huge numerical memory and increases the computation time considerably.

4.3.3.8 Convergence criteria on temperature

The advanced user input “**Converg. Criteria on temperature**” (*Convergence criteria on temperature*) is a percentage driving the convergence of the computation.

This advanced user input is available when the iterative thermal solving mode is selected in the thermal settings.

The iterative process (loop between electromagnetic and thermal computations) must run until the convergence criteria has been reached leading to the electromagnetic-thermal steady state. The convergence process is completed when the variation of temperature between two iterations gets lower than the ratio “**Converg. Criteria on temperature**” set in input.

Convergence criteria on temperature is set to 1.0 % by default.

The variation range of values for this percentage is]0;10].

A percentage close to zero gives more accurate results, but a longer computation time. A high percentage can make the convergence shorter but decreases the accuracy of the results. The default value of 1.0% gives a good balance between the accuracy and computation time on most of the computations, but a smaller value can also be required to increase the computation accuracy on some working points.

Note: Two conditions are required to make the “Convergence criteria” available:

- The type of machine is Synchronous Machine with Permanent Magnets with Inner rotor (Thermal computations are available only for inner rotor machines)
- One of the two following thermal solving modes is selected: One iteration or iterative computation until convergence mode.

4.4 Main principles of computation

4.4.1 Introduction

The aim of this test in generator convention is to give a good overview of the electromagnetic potential of the machine by characterizing the working point according to the line current, control angle and speed set by the user. In addition, ripple torque at the working point is also computed.

Two computation modes are available:

- “Fast computation mode” is perfectly suited for the pre-design step to explore the space of solutions quickly and easily (Hybrid model based on magnetostatic FE computations and Park transformation)
- “Accurate computation mode” is perfectly suited for the final design step because it allows getting more accurate results and to compute additional quantities like the AC losses in winding, rotor iron losses and Joule losses in magnets (Pure FE model based on transient computations)

4.4.2 Fast computation mode

4.4.2.1 Working point - Definition

To compute the working point, the principle consists of positioning the magnet axis towards the reference phase axis by considering the targeted control angle.

At the same time, the targeted line current and speed are imposed.

Then, the resulting behavior of the machine can be simulated, and all the main electromagnetic characteristics of the machine can be deduced by using Park’s transformation and associated electric equations.

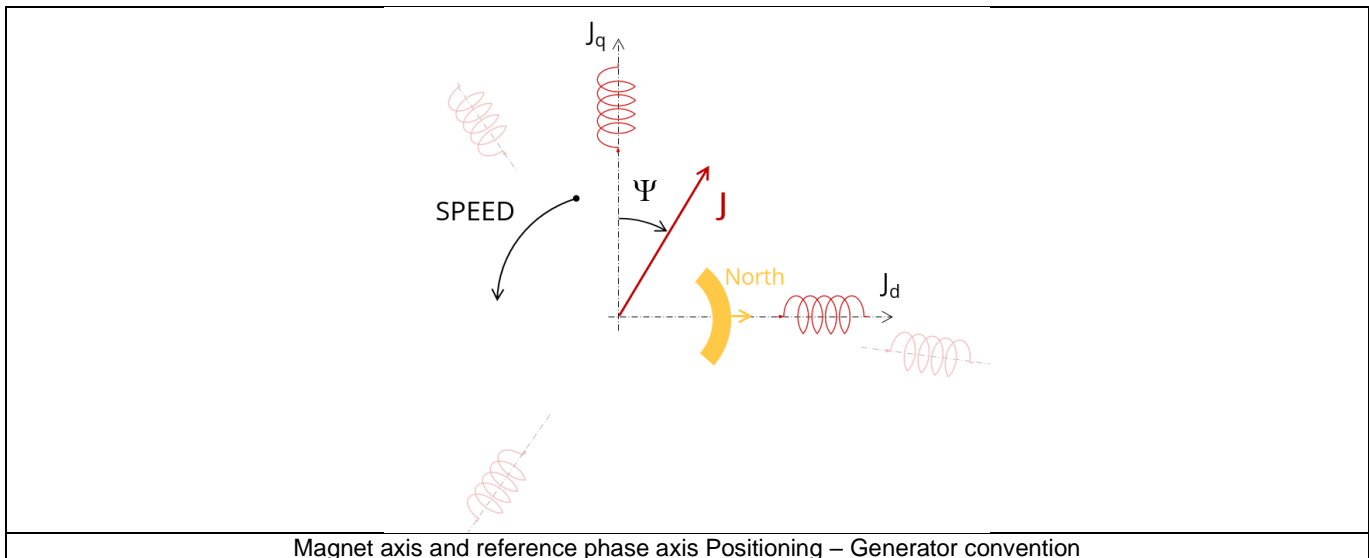

Note: In generator operating mode, mechanical power provided on the shaft must be higher than losses otherwise the electrical power is negative, and no current can be supplied by the generator.

It is why, at low speed, for each value of mechanical torque, a minimum speed always exists to be able to supply electrical current. In FluxMotor®, this limit at no-speed is called “Minimum speed point”.

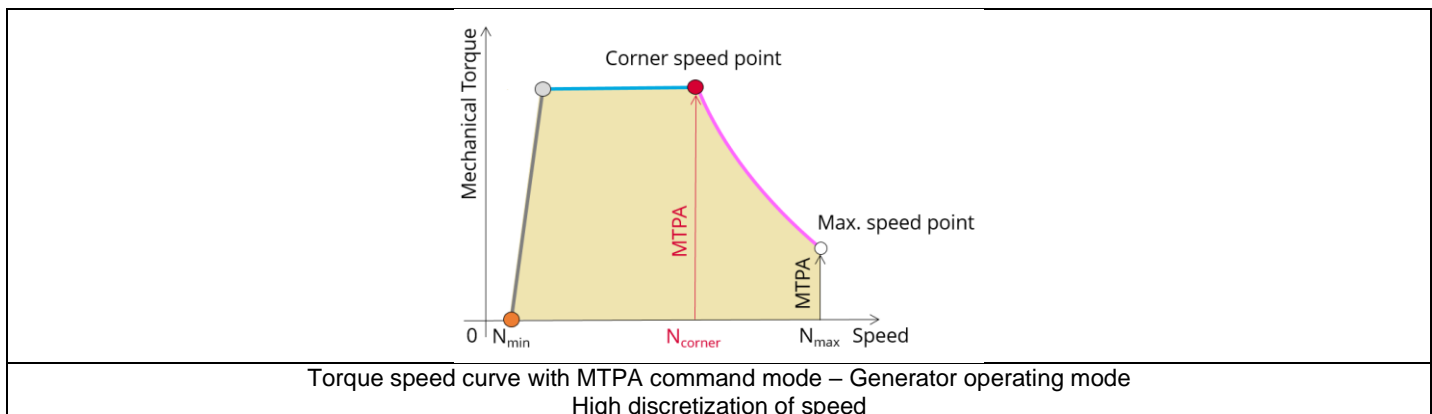

Note: When the machine has high losses at high speed some working points can be unreachable. Resulting torque-speed curves and maps look like as the following figure:

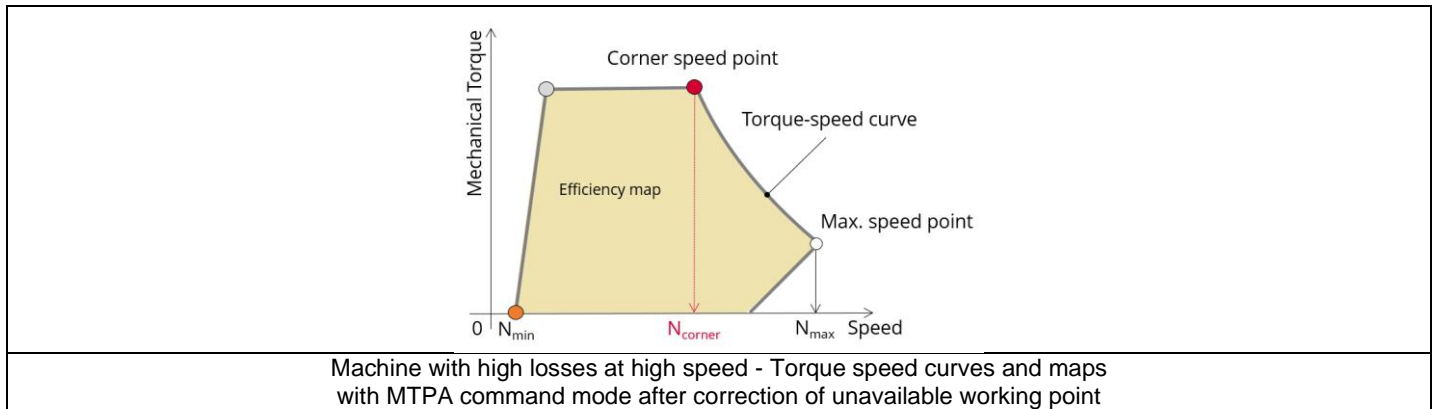

So, when the targeted working point is in an unreachable zone (left or right white area of the figure above), a warning message is issued by FluxMotor® and the efficiency is set at “-”. All other computed results are available and can be analyzed (power balance) for targeting a reachable working point.

4.4.2.2 Electromagnetic behavior – General information

The method used for computation of electromagnetic behavior depends on if ripple torque analysis is set to “Yes” or “No”:

- “Yes” is selected: The analysis of the electromagnetic behavior is done over one ripple torque period (when torque ripple computation is not performed).
- “No” is selected: The analysis of the electromagnetic behavior is done with a dedicated static computation (1 rotor position to be considered) done for the working point computed (with line current, control angle and speed obtained for the working point).

4.4.2.3 Flux in airgap

The flux in the airgap is always computed thanks to the dedicated static computation of the working point.

The airgap flux density is computed along an airgap path in Flux® software. The resulting signal is obtained for at least an electric period. The average and the peak value of the flux density are also computed. The harmonic analysis of the flux density in airgap versus rotor position is done to compute the magnitude of the first harmonic of the flux density.

4.4.2.4 Flux density in iron

Mean and maximum values of flux density of each iron region are computed with the help of sensors in Flux® software.

4.4.2.5 Magnet behavior

Mean values of flux density and magnetic field inside the magnets are computed with the help of sensors in Flux® software. Based on these results, demagnetization rate of the magnets is computed.

4.4.2.6 Ripple torque

A specific computation is performed to determine the rate of ripple torque precisely.

Considering J_d and J_q at the base speed point, a computation is performed over one ripple torque period by using Finite Element modelling (Flux® software – Magnetostatic application).

Many computation points are considered over the ripple torque period (advanced user input: **No. comp. / ripple period**).

The following steps are performed to determinate the mechanical torque.

1) Original computation of the electromagnetic torque

The magnetic torque exerted on a non-deformable part of the domain is computed by the virtual work method. The torque in a given direction is obtained by deriving the system energy with respect to a virtual displacement of the part in this direction.

The magnetic torque T_{em} is given by the following derivative:

$$T_{em} = - \frac{\partial W_m}{\partial \theta}$$

$\partial \theta$ = elementary angular displacement,

W_m = magnetic energy in the regional volume

The electromagnetic ripple torque is computed over the ripple torque period with respect of the rotor angular position $T_{em,\theta}$. The mean value " $T_{em, mean}$ " can also be computed.

2) Mechanical ripple torque based on Park's model

The mechanical ripple torque must be computed at the base speed.

First, we compute the electromagnetic torque " $T_{em, Park}$ " with Park's model:

$$T_{em, Park} = \frac{m}{2} \times p \times (\Phi_d \times J_q - \Phi_q \times J_d)$$

Then, the iron loss torque, the mechanical loss torque and the additional loss torque are subtracted from " $T_{em, Park}$ " to get the corresponding mean value of the mechanical torque " $T_{mech, Park}$ ".

3) Resulting mechanical torque versus rotor angular position

To compute the resulting mechanical ripple torque, the original electromagnetic torque computed previously is weighted by the ratio of the mean value of the mechanical torque based on Park's model ($T_{mech, Park}$) and of the mean value of the original electromagnetic ripple torque ($T_{em, mean}$).

$$T_{mech,\theta} = T_{em,\theta} \times \frac{T_{mech, Park}}{T_{em, mean}}$$

The peak-peak value of the mechanical ripple torque is then computed. The rate of ripple torque is deduced as a percentage or per unit of the nominal torque.

Warning: When the ripple torque computation is not requested, the computation of the working point is performed by considering only one position within the electrical period. It means that all the data characterizing the behavior of the machine can change based on the selection of ripple torque (Yes/No).

Flux density in magnetic circuit and the magnet behavior will be more accurately computed when the computation of the ripple torque will be requested.

4.4.3 Accurate computation mode

4.4.3.1 Working point - Definition

Working point computation is based on a transient magnetic finite element simulation over a half, one or several electrical periods for a given set of inputs: control angle, line current and speed defined as for the Fast computation mode.

Thus, all the main electromagnetic characteristics of the machine can be deduced accurately.

4.4.3.2 Electromagnetic behavior – General information

All the main quantities are directly computed from the Flux® software in the framework of a transient magnetic finite element simulation.

4.4.3.3 Iron losses

Iron losses (stator and rotor) are computed, thanks to the "transient modified Bertotti model" in Flux® software.

4.4.3.4 Magnet losses

Magnet losses are computed thanks to the sensors defined for each corresponding region in Flux® software.

4.4.3.5 Stator Joule winding losses

The stator's DC Joule losses are always computed.

However, if AC losses analysis is set to "FE-One phase" or "FE-all phase" stator AC Joule losses are computed in addition to stator's DC Joule losses.

FE-One phase: AC losses are computed with only one phase modeled for solid conductors (wires) inside the slots. The two other ones are modeled with coil regions. Thus, AC losses in winding are computed with a lower computation time than if all the phases were modeled with solid conductors. However, this can have a little impact on the accuracy of results because we have supposed that the magnetic field is not impacted by the modeling assumption.

FE-All phase: AC losses are computed, with all phases modeled with solid conductors (wires) inside the slots. This computation method gives the best results in terms of accuracy, but with a higher computation time.

FE-Hybrid: AC losses in winding are computed without representing the wires (strands, solid conductors) inside the slots. Since the location of each wire is accurately defined in the winding environment, sensors evaluate the evolution of the flux density close each wire. Then, a postprocessing based on analytical approaches computes the resulting current density inside the conductors and the corresponding Joule losses.

With the "FE-Hybrid" option the accuracy of results is good especially when the wire size is small (let's say wire diameter lower than 2.5 mm). However, this can have a little impact on the accuracy of results because we have supposed that the magnetic field is not impacted by the modeling assumption.

In FluxMotor®, stator AC Joule losses corresponds to the additional losses induced by fields and skin effects in the conductors (wires) at high speed. The circulating current between parallel path or/and conductor wires are also considered in the modeling. In case of AC losses, the total stator Joule losses ($W_{\text{Stator Joule Tot.}}$) is given by:

$$W_{\text{Stator Joule Tot.}} = W_{\text{Stator DC Joule Tot.}} + W_{\text{Stator AC Joule Tot.}}$$

Each term "AC and DC" are themselves divided in two parts: the "winding active length part" (lamination part) and the "end winding part".

$$W_{\text{Stator DC Joule Tot.}} = W_{\text{Stator DC Joule W.A.L.}} + W_{\text{Stator DC Joule E.W.}}$$

$$W_{\text{Stator AC Joule Tot.}} = W_{\text{Stator AC Joule W.A.L.}} + W_{\text{Stator AC Joule E.W.}}$$

In the winding active length part (W.A.L), field effect, skin effect and circulating current are considered.

In the end ring part (E.W), field effect and skin effect are neglected, only circulating current are considered. This allows to identify the amount of AC losses induced by circulating current between wires of conductors (Circulating current are induced by the unbalance of impedance of wires of a conductor itself induced by the field variation in conjunction of each wire position in a conductor).

Thanks to AC losses computation, "stator winding resistance ratio" are computed for the "total resistance", the "Winding Active Length resistance" and the "End Winding resistance". Ratios are computed by following the below equations:

$$R_{s \text{ AC/DC}} = \frac{W_{\text{Stator DC Joule Tot.}} + W_{\text{Stator AC Joule Tot.}}}{W_{\text{Stator DC Joule Tot.}}}$$

$$R_{s \text{ w.a.l. AC/DC}} = \frac{W_{\text{Stator DC Joule W.A.L.}} + W_{\text{Stator AC Joule W.A.L.}}}{W_{\text{Stator DC Joule W.A.L.}}}$$

$$R_{s \text{ e.w. AC/DC}} = \frac{W_{\text{Stator DC Joule E.W.}} + W_{\text{Stator AC Joule E.W.}}}{W_{\text{Stator DC Joule E.W.}}}$$

4.4.3.6 Flux density in iron

Mean and maximum values of flux density of each iron region are computed with the help of sensors in Flux® software.

4.4.3.7 Magnet behavior

Mean values of flux density and magnetic field inside the magnets are computed with the help of sensors in Flux® software. Based on these results, demagnetization rate of the magnets is computed.

4.4.3.8 Torque

The magnetic torque exerted on a non-deformable part of the domain is computed by the virtual work method. The torque in a direction is obtained by deriving the system energy with respect to a virtual displacement of the part in this direction.

The magnetic torque T_{em} is given by the following derivative:

$$T_{em} = - \frac{\partial W_m}{\partial \theta}$$

$\partial \theta$ = elementary angular displacement,

W_m = magnetic energy in the regional volume

The electromagnetic torque is computed over the electrical period with respect to the rotor angular position $T_{em,\theta}$.

Then, the mean value of the electromagnetic torque is computed " $T_{em, mean}$ ". The iron loss torque, the mechanical loss torque and the additional loss torque are subtracted from " $T_{em, mean}$," to get the corresponding mean value of the mechanical torque " $T_{mech, mean}$ ". To compute the resulting mechanical ripple torque, the mean electromagnetic torque previously computed is weighted by the ratio of the mean value of the mechanical torque ($T_{mech, mean}$) and the mean value of the original electromagnetic torque ($T_{em, mean}$).

$$T_{mech,\theta} = T_{em,\theta} \times \frac{T_{mech,mean}}{T_{em,mean}}$$

The peak-peak value of the mechanical ripple torque is then computed. The rate of ripple torque is deduced as a percentage or per unit of the nominal torque.

4.4.3.9 Flux in airgap

The airgap flux density is computed with a sensor which is defined in the static part of the airgap under a tooth in Flux® software. The resulting signal is obtained over an electric period. The average and the peak value of the flux density are also computed. The harmonic analysis of the phase voltage is done to evaluate the harmonics content.

4.4.3.10 Phase voltage

The phase voltage is computed with a sensor defined in the electrical circuit in Flux® software. The resulting signal is obtained over an electric period. The harmonic analysis of the phase voltage is done to evaluate the harmonics content.

4.4.3.11 Phase current

The phase current is computed with a sensor defined in the electrical circuit in Flux® software. The resulting signal is obtained over an electric period. The harmonic analysis of the phase voltage is done to evaluate the harmonics content very useful in case of delta winding coupling.

4.5 Test results

Once a test is finished, the corresponding results are automatically displayed in the central window.

4.5.1 Test conditions

4.5.1.1 Inputs

All the parameter values, belonging to standard inputs or advanced inputs are described in this section. It shows the initial conditions considered for the test.

Here are the displayed subsections:

- Context
- Standard parameters
- Advanced parameters

For more information refer to the section 4.3 (Inputs).

4.5.1.2 Settings

All the settings dedicated to the test along with the thermal characteristics are displayed in this section.

Here is the displayed subsection:

- Thermal
- Mechanics

4.5.1.3 Winding and magnet characteristics

All winding and magnet characteristics are displayed in the following subsections:

- Magnet characteristics
- Winding characteristics

For more details, please refer to the document: MotorFactory_SMPM_IOR_3PH_Test_Introduction – section “Machine characteristics”.

4.5.2 Main results

4.5.2.1 Machine performance – Working point

Output data displayed in the following subsections are described in the section Working point – Sine wave – Motor.

Here are the displayed subsections:

- General data
- Machine constants
- Power balance
- Flux in airgap
- Flux density in iron
- Magnet behavior

Output data displayed in the following area list are described in the document: MotorFactory_SMPM_IOR_3PH_Test_Introduction – section Working point – Sine wave – Display of results.

4.5.2.2 Ripple mechanical torque

The analysis of the ripple torque is presented in the table “Ripple mechanical torque” with the following subsections:

- Working point

For more details, please refer to the document: MotorFactory_SMPM_IOR_3PH_Test_Introduction – sections dealing with “Power electronics mode settings”.

4.5.3 Curves - Fast

- Ripple mechanical torque versus rotor angular position
- Flux density in airgap versus rotor angular position
- Chart of temperature (radial and axial views)

4.5.4 Curves - Accurate

- Mechanical torque versus rotor angular position
- Mechanical torque harmonic analysis
- Flux density in airgap versus rotor angular position
- Flux density in airgap harmonic analysis
- Phase voltage versus rotor angular position
- Phase voltage harmonic analysis
- Phase current versus rotor angular position
- Phase current harmonic analysis

4.5.5 Isovalues and isolines

The flux density isovalues and the vector potential isolines can be displayed.

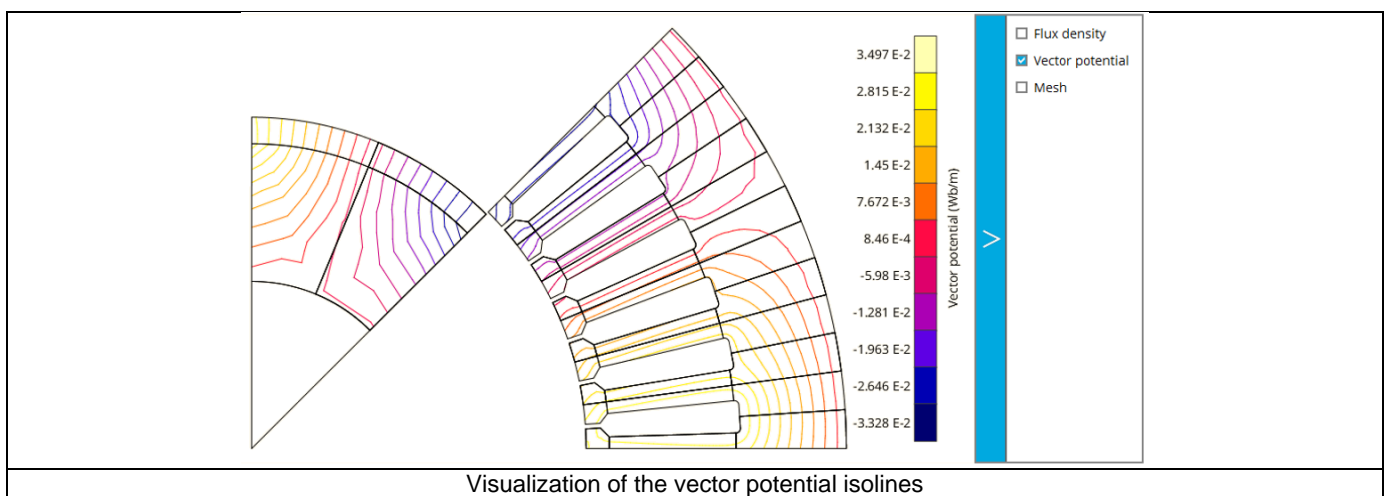
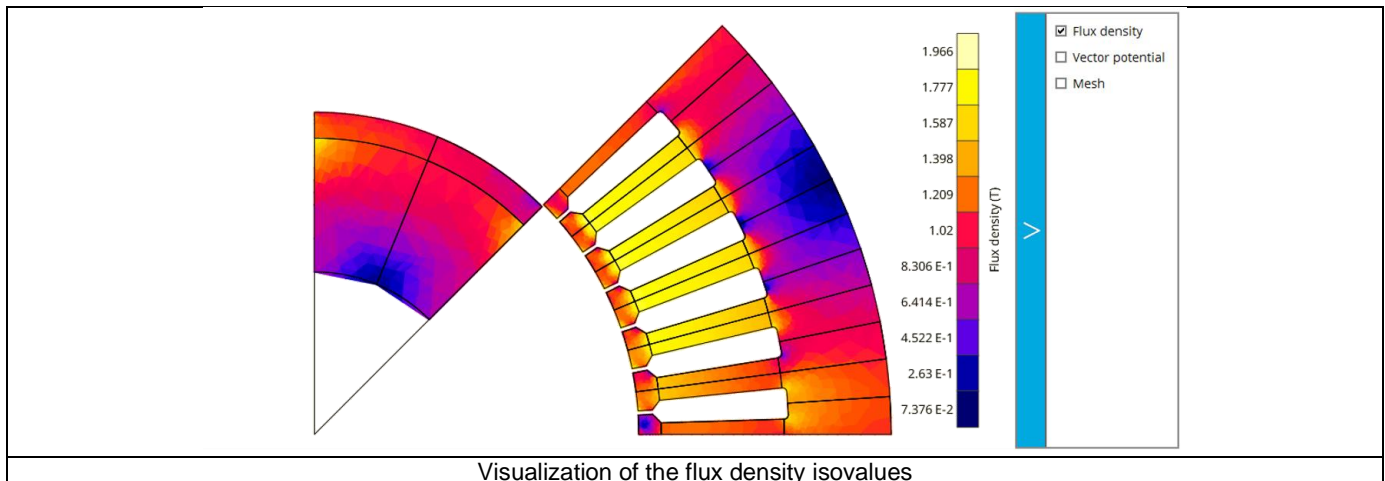

Note: The visualization of the meshing of the model can also be displayed.

4.5.6 Chart and table of temperatures

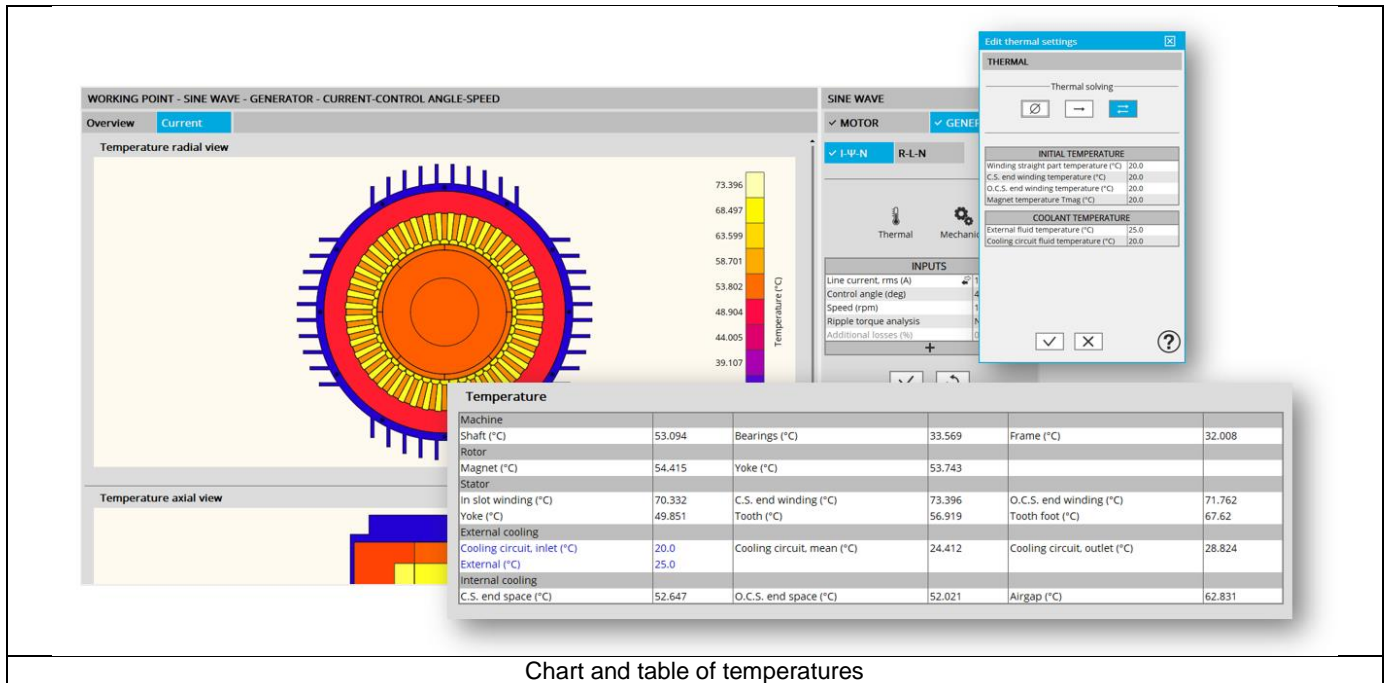

Chart and table of temperatures

4.5.7 Limitation of thermal computations - Advice for use

Notes:

- 1) Setting a skew angle modifies the electromagnetic performance of the machine, including the losses. For electromagnetic/thermal iterative solving, the losses are then considered as inputs of the thermal computation. This means that in "One iteration" or "Iterative" solving modes, the temperatures reached in the machine will change depending on the skew angle in input.
- 2) The resistance network identification of a machine is always done without any skew angle. This can bring some inaccuracy in the results for highly skewed machines.
- 3) For additional information, please refer to the document: MotorFactory_SMPM_IOR_3PH_Test_Introduction – section "Limitation of thermal computations – Advice for use"

5 WORKING POINT – SINE WAVE – GENERATOR – R, L LOAD & SPEED

5.1 Overview

5.1.1 Positioning and objective

The aim of the test “**Working point – Sine wave – Generator – R-L-N**” is to characterize the generator performance when operating with a star-connected 3-phase R, L load at the targeted speed N.

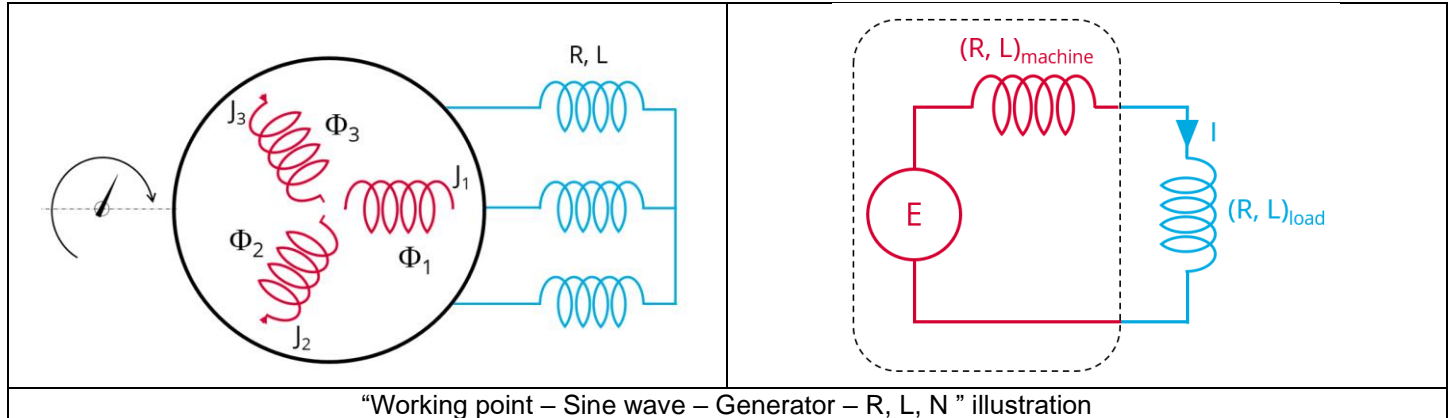

The results of this test give an overview of the electromagnetic analysis of the machine considering the machine topology. The general data of the machine, like machine constants, power balance and magnet behavior are computed and displayed. The considered convention is the generator one. The magnetic flux density is also computed in every region of the machine magnetic circuit to evaluate the design.

The following table helps to classify the test “Working point – Sine wave – Generator – R, L, N”.

Family	Working point
Package	Sine wave
Convention	Generator
Test	R, L, N

Positioning of the test “Working point – Sine wave – Generator – R, L, N”

5.1.2 User inputs

The three main user input parameters are the characteristics of the load (R, L) and the speed. In addition, temperatures of winding and magnets and mechanical losses must be set.

5.1.3 Main outputs

Test results are illustrated with data, graphs and tables

5.1.3.1 Tables of results

- 1) Machine performance – Open circuit data
 - Results
- 2) Machine performance – Base speed point
 - General data
 - Machine constants
 - Power balance
 - Flux in airgap
 - Flux density in iron
 - Magnet behavior including evaluation of demagnetization rate
- 3) Ripple mechanical torque
 - Working point

5.1.3.2 Curves

- 1) Ripple mechanical torque versus rotor angular position
- 2) Flux density in airgap versus rotor angular position

5.2 Settings

Two buttons give access to the following setting definition:

- Temperature of active components: winding and magnets
- Definition of mechanical loss model parameters

For more details, please refer to the document: MotorFactory_SMPM_IOR_3PH_Test_Introduction – sections dealing with settings.

5.3 Inputs

5.3.1 Introduction

The total number of user inputs is equal to 11.
Among these inputs, 5 are standard inputs and 6 are advanced inputs.

5.3.2 Standard inputs

5.3.2.1 Load resistance

The phase resistance of the 3-phase star connected load "**Load resistance**" (*Phase resistance of the 3-phase load*) load must be set.
The default value is 1 Ω .

5.3.2.2 Load inductance

The phase inductance of the 3-phase star connected load "**Load inductance**" (*Phase inductance of the 3-phase load*) load must be set.
The default value is 1.0E-4 H.

5.3.2.3 Speed

The imposed "Speed" of the machine must be set.

5.3.2.4 Ripple torque analysis

The "**Ripple torque analysis**" (*Additional analysis on ripple torque period: Yes / No*) allows to compute or not the value of the ripple torque and to display the corresponding torque versus the angular position over the ripple torque period.
The default value is "No".

Notes:

- This choice influences the accuracy of results and the computation time. The peak-peak ripple torque is calculated.
This additional computation needs additional computation time.
- In case of "Yes", the ripple torque is computed.
Then, the flux density in regions and the magnet demagnetization rate are evaluated through the ripple torque computation.
- In case of "No", the ripple torque is not computed.
Then, the flux density in regions and the magnet demagnetization rate are evaluated by considering the Park's model computation.

5.3.2.5 Additional losses

"Additional losses" input is not available in the current version (The input label is written in grey).

5.3.3 Advanced inputs

5.3.3.1 Number of computations per ripple torque period

The number of computations per ripple torque period is considered when the user has chosen to perform a “Ripple torque analysis” (i.e. answered “Yes” to the standard input “Ripple torque analysis”).

The user input “**No. comp. / ripple period**” (Number of computations per ripple torque period) influences the accuracy of results (computation of the peak-peak ripple torque) and the computation time.

The default value is equal to 30. The minimum allowed value is 25. The default value provides a good compromise between the accuracy of results and computation time.

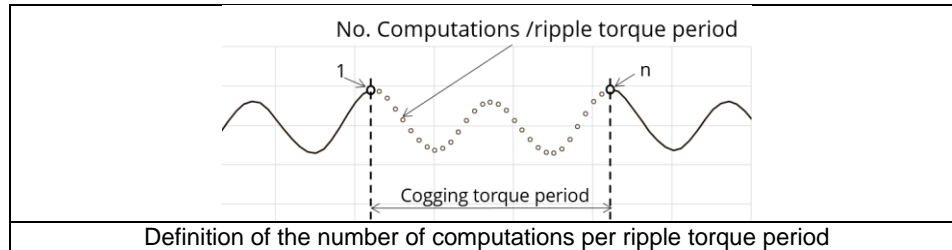

5.3.3.2 Rotor initial position

By default, the “**Rotor initial position**” is set to “**Auto**”.

When the “**Rotor initial position mode**” is set to “**Auto**”, the initial position of the rotor is automatically defined by an internal process of FluxMotor®.

The resulting relative angular position corresponds to the alignment between the axis of the stator phase 1 (reference phase) and the direct axis of the rotor north pole.

When the “**Rotor initial position**” is set to “**User input**” (i.e., toggle button on the right), the initial position of the rotor considered for computation must be set by the user in the field « **Rotor initial position** ». The default value is equal to 0. The range of possible values is [-360, 360].

For more details, please refer to the document: MotorFactory_SMPM_IOR_3PH_Test_Introduction – section “Rotor and stator relative position”.

5.3.3.3 Skew model – Number of layers

When the rotor magnets or the stator slots are skewed, the number of layers used in Flux® Skew environment to model the machine can be modified: “**Skew model - No. of layers**” (*Number of layers for modelling the skewing in Flux® Skew environment*).

5.3.3.4 Mesh order

To get the results, the original computation is performed using a Finite Element Modeling.

Two levels of meshing can be considered for this finite element calculation: first order and second order.

This parameter influences the accuracy of results and the computation time.

By default, second order mesh is used.

5.3.3.5 Airgap mesh coefficient

The advanced user input “**Airgap mesh coefficient**” is a coefficient which adjusts the size of mesh elements inside the airgap. When the value of “**Airgap mesh coefficient**” decreases, the mesh elements get smaller, leading to a higher mesh density inside the airgap and increasing the computation accuracy.

The imposed Mesh Point (size of mesh elements touching points of the geometry), inside the Flux® software, is described as:

$$\text{MeshPoint} = (\text{airgap}) \times (\text{airgap mesh coefficient})$$

Airgap mesh coefficient is set to 1.5 by default.

The variation range of values for this parameter is [0.05; 2].

0.05 giving a very high mesh density and 2 giving a very coarse mesh density.

Caution:

Be aware, a very high mesh density does not always mean a better result quality. However, this always leads to a huge number of nodes in the corresponding finite element model. So, it means a need of huge numerical memory and increases the computation time considerably.

5.3.3.6 Convergence criteria on current

The advanced user input “**Converg. Criteria on current**” (*Convergence criteria on current*) is a percentage driving the convergence of the computation.

During the computation, the process iterates to find the working point (current in DQ area) occurring in the generator feeding the load. The convergence process is completed when the variation of current between two iterations gets lower than the ratio “**Converg. Criteria on current**” set in input.

Convergence criteria on current is set to 0.5% by default.

The variation range of values for this percentage is]0;10].

A percentage close to zero gives more accurate results, but a longer computation time. A high percentage can make the convergence shorter but decreases the accuracy of the results. The default value of 0.5% gives a good compromise between accuracy and computation time on most of the computations, but smaller value can be required to increase the computation accuracy on some working points, especially working points close to the open circuit behavior.

5.4 Main principle of computation

5.4.1 Steady state behavior

The aim of this test is to define the behavior of the generator when a star connected 3-phase load (resistance R and inductance L in series) is put at its terminal ends. It gives a good overview of the electromagnetic behavior of the machine by characterizing the resulting working point.

The principle of this test is to iterate on the working point occurring in the generator (current in DQ area), until converging on the working point corresponding to the R-L load plugged to the generator.

The convergence process is driven by an equivalent circuit of the machine connected to the load. In each iteration, finite element software Flux is called to compute the magnetic behavior of the machine and set accurately the parameters of the equivalent circuit.

After the needed iterations, the process gives the magnetic behavior of the machine connected to the load, and all data corresponding to this working point.

All the equations are written by considering the generator convention.

For more information, please refer please refer to the document: MotorFactory_SMPM_IOR_3PH_Test_Introduction – section “Electrical machine – Theoretical equations” where the general presentation of the machine characteristics is presented.

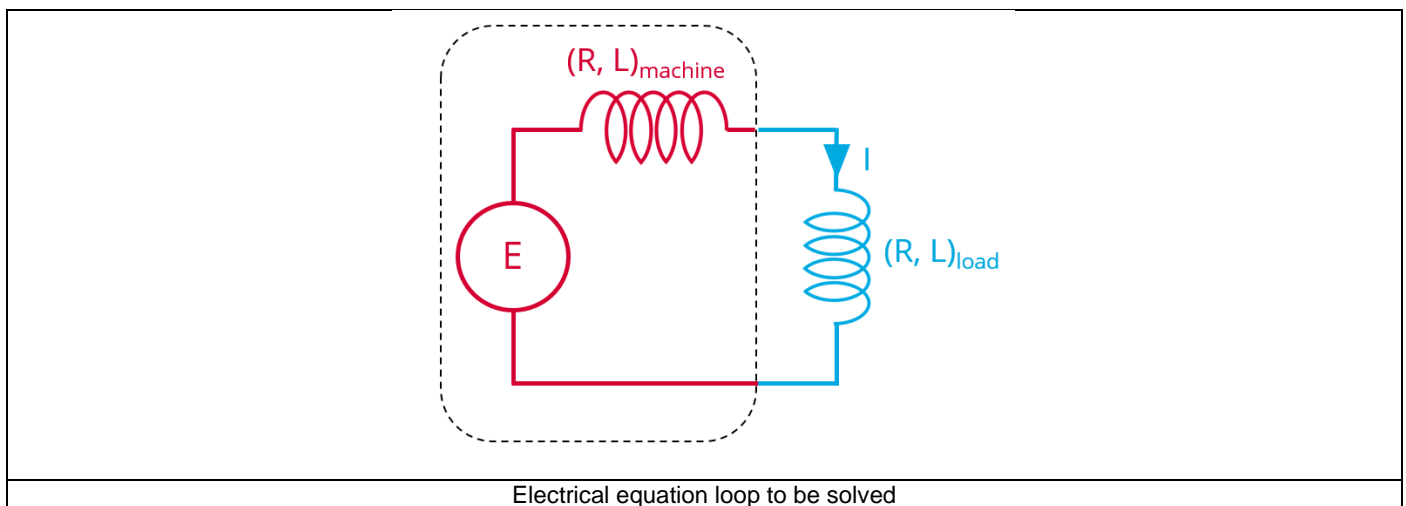

5.4.2 Electromagnetic behavior

5.4.2.1 Introduction

Used method of electromagnetic behavior computation depends on if ripple torque analysis is set to “Yes” or to “No”:

- “Yes” is selected: The analysis of the electromagnetic behavior is done over one ripple torque period (when torque ripple computation is not performed).
- “No” is selected: The analysis of the electromagnetic behavior is done with a dedicated static computation (1 rotor position to be considered) done for the working point computed (with line current, control angle and speed obtained for the working point).

5.4.2.2 Flux in airgap

The flux in the airgap is always computed thanks to the dedicated static computation of the working point.

The airgap flux density is computed along a path in the airgap in Flux® software. The resulting signal is obtained over at least an electric period. The average and the peak value of the flux density are also computed. A harmonic analysis of the flux density in airgap versus rotor position is done to compute the magnitude of the first harmonic of the flux density.

5.4.2.3 Flux density in iron

Mean and maximum values of flux density of each iron region are computed thanks to sensors in Flux® software.

5.4.2.4 Magnet behavior

Mean values of flux density and magnetic field inside the magnets are computed thanks to sensors in Flux® software. Based on these results, demagnetization rate of the magnets is computed.

5.4.3 Ripple torque

A specific computation is performed to precisely determine the rate of ripple torque.

Considering J_d and J_q at the base speed point, a computation is performed over one ripple torque period by using Finite Element modelling (Flux® software – Magnetostatic application).

Many computation points are considered over the ripple torque period (advanced user input: **No. comp. / ripple period**).

The following steps are performed to determinate the mechanical torque.

5.4.3.1 Original computation of the electromagnetic torque

The magnetic torque exerted on a non-deformable part of the study domain is computed by the virtual work method. The torque in a given direction is obtained by deriving the system energy with respect to a virtual displacement of the part in this direction.

The magnetic torque T_{em} is given by the following derivative:

$$T_{em} = -\frac{\partial W_m}{\partial \theta}$$

$\partial \theta$ = elementary angular displacement,

W_m = magnetic energy in a volume region

The electromagnetic ripple torque is computed over the ripple torque period versus the rotor angular position $T_{em,\theta}$. The mean value “ $T_{em,mean}$ ” is computed

5.4.3.2 Mechanical ripple torque based on Park’s model

The mechanical ripple torque must be computed at the base speed.

First, we compute the electromagnetic torque “ $T_{em, Park}$ ” with Park’s model:

$$T_{em, Park} = \frac{m}{2} \times p \times (\Phi_d \times J_q - \Phi_q \times J_d)$$

Then, the iron loss torque, the mechanical loss torque and the additional loss torque are subtracted from “ $T_{em, Park}$ ” to get the corresponding mean value of the mechanical torque “ $T_{mech, Park}$ ”.

5.4.3.3 Resulting mechanical torque versus rotor angular position

To compute the resulting mechanical ripple torque, the original electromagnetic torque previously computed is weighted by the ratio of the mean value of the mechanical torque based on Park's model ($T_{\text{mech, Park}}$) and of the mean value of the original electromagnetic ripple torque ($T_{\text{em, mean}}$).

$$T_{\text{mech},\theta} = T_{\text{em},\theta} \times \frac{T_{\text{mech, Park}}}{T_{\text{em, mean}}}$$

The peak-peak value of the mechanical ripple torque is then computed. The rate of ripple torque is deduced as a percentage or per unit of the nominal torque.

Warning: When the ripple torque computation is not requested, the computation of the working point is performed by considering only one position within the electrical period. It means that all the data characterizing the behavior of the machine can change based on the selection of ripple torque (Yes/No).

Flux density in magnetic circuit and the magnet behavior will be more accurately computed when the computation of the ripple torque will be requested.

5.5 Test results

Once a test is finished, the corresponding results are automatically displayed in the central window.

5.5.1 Test conditions

5.5.1.1 Inputs

All the parameter values, belonging to standard inputs or advanced inputs are described in this section.

It shows the initial conditions considered for the test.

Here are the displayed subsections:

- Context
- Standard parameters
- Advanced parameters

For more information refer to the section 5.3 (Inputs).

5.5.1.2 Settings

All the settings dedicated to the test and dealing with the thermal are displayed in this section.

Here is the displayed subsection:

- Thermal
- Mechanics

5.5.1.3 Winding and magnet characteristics

All winding and magnet characteristics are displayed in the following subsections:

- Magnet characteristics
- Winding characteristics

For more details, please refer to the document: MotorFactory_SMPM_IOR_3PH_Test_Introduction – section “Machine characteristics”.

5.5.2 Main results

5.5.2.1 Machine performance – Open circuit

Here are the displayed subsections:

- Results

This section contains the No load magnetic flux. It corresponds to the maximum amount of flux linkage through one phase due to magnets only (without current excitation)

5.5.2.2 Machine performance – Working point.

Output data displayed in the following subsections are described in section Working point – Sine wave – Motor.

Here are the displayed subsections:

- General data
- Machine constants
- Power balance
- Flux in airgap
- Flux density in iron
- Magnet behavior

Output data displayed in the following area list are described in the document: MotorFactory_SMPM_IOR_3PH_Test_Introduction – section Working point – Sine wave – Display of results.

5.5.2.3 Ripple mechanical torque

The analysis of the ripple torque is presented in the table “Ripple mechanical torque” with the following subsections:

- Working point

For more details, please refer to the document: MotorFactory_SMPM_IOR_3PH_Test_Introduction – sections dealing with “Working point – Sine wave – Display of results”.

5.5.3 Curves

- Ripple mechanical torque versus rotor angular position
- Flux density in airgap versus rotor angular position

6 WORKING POINT – SQUARE WAVE – MOTOR – FORCED I

6.1 Overview

6.1.1 Positioning and objective

The aim of the test “**Working point – Square wave – Motor – Forced I**” is to characterize the behavior of the machine when operating with a forced current defining a square wave drive.

A parameterized trapezoidal shape current defines the line current.

The control angle between the back-emf and the phase current, the value of current and the imposed speed induce the resulting working point. Then, the main corresponding performance are computed and displayed.

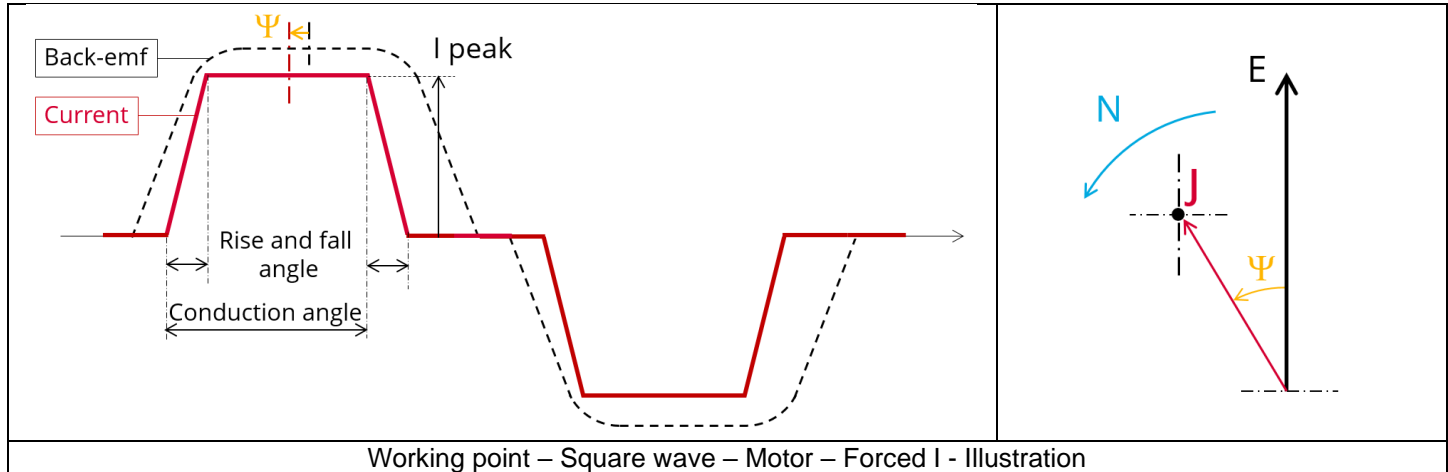

All the results are computed from a Finite Element Analysis (Flux) - Transient application. The results of this test give an overview of the electromagnetic behavior of the considered motor.

The general data of the machine, like machine constants, power balance and magnet behavior are computed and displayed.

The magnetic flux density is also computed in every region of the machine magnetic circuit to evaluate the design.

The following table helps to classify the test “Working point – Square wave – Motor – Forced I”.

Family	Working point
Package	Square wave
Convention	Motor
Test	Forced I

Positioning of the test “Working point – Square wave – Motor – Forced I”

Warning: When running the test “Working point – Square wave – Motor – Forced I” with a delta winding connection. Two electrical periods are considered for reaching a steady state behavior of the motor. However, sometimes two periods could not be enough to get a good convergence of our process.

6.1.2 User inputs

The main user input parameters are the supplied line current, the speed, the control angle, the conduction angle and the rise and fall angle. In addition, temperatures of winding and magnets must be set.

6.1.3 Main outputs

Test results are illustrated with data, graphs and tables

6.1.3.1 Tables of results

- 1) Machine performance – working point
 - General data
 - Machine constants
 - Power balance
 - Iron losses
 - Flux in airgap
 - Flux density in iron
 - Magnet behavior including evaluation of demagnetization rate

- 2) Ripple mechanical torque
 - Working point

6.1.3.2 Curves

- 1) Normalized back-emf, phase currents and mechanical torque versus time – Working point
- 2) Phase voltage versus time – Open circuit
- 3) Mechanical torque versus time – Working point
- 4) Phase voltage versus time – Working point
- 5) Line-line voltage versus time – Working point
- 6) Phase current versus time – Working point
- 7) Line current versus time – Working point
- 8) Power versus time – Working point
- 9) Losses versus time – Working point

6.2 Settings

Three buttons give access to the following setting definition:

- Temperature of active components: winding and magnets
- Definition of mechanical loss model parameters

For more details, please refer to the document: MotorFactory_SMPM_IOR_3PH_Test_Introduction – sections dealing with settings.

6.3 User inputs

6.3.1 Introduction

The total number of user inputs is equal to 15.

Among these inputs, 10 are standard inputs and 5 are advanced inputs.

6.3.2 Standard inputs

6.3.2.1 Current definition mode

There are 2 common ways to define the electrical current.

Electrical current can be defined by the current density in electric conductors. In this case, the current definition mode should be « **Density** ».

Electrical current can be defined directly by indicating the value of the line current (the peak value is required). In this case, the current definition mode should be « **Current** ».

6.3.2.2 Current density, peak

When the choice of current definition mode is “**Density**”, the peak value of the current density in electric conductors “**Current density, peak**” (*Current density in conductors, peak value*) must be provided.

Note: The number of parallel paths and the winding connection are automatically considered in the results.

Warning: In the case of a delta-connection winding, the user input “current density” gives an evaluation of the value to reach. However, this doesn’t consider the current circulating in the loop of the delta winding. So, there can be a difference (sometimes very important) between the targeted value and the current density in conductors resulting from computations. In any case, the resulting value of current density in conductors is computed and displayed in the table of results.

6.3.2.3 Line current, peak

When the choice of current definition mode is “**Current**”, the peak value of the line current supplied to the machine: “**Line current, peak**” (*Line current, peak value*) must be provided.

Note: The number of parallel paths and the winding connections are automatically considered in the results.

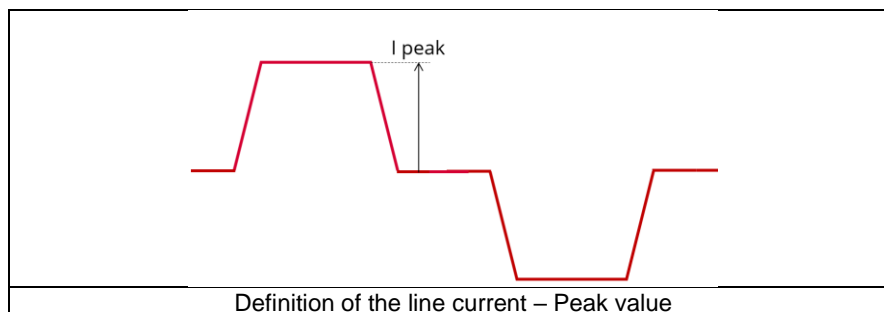

6.3.2.4 Speed

The imposed “**Speed**” (*Speed*) of the machine must be set.

6.3.2.5 Control angle

Considering the vector diagram shown below, the “**Control angle**” is the angle between the electromotive force E and the electrical phase current (J) ($\Psi = (E, J)$).

The default value is 0 degrees. It is an electrical angle. It must be set in a range of -90 to 90 degrees.

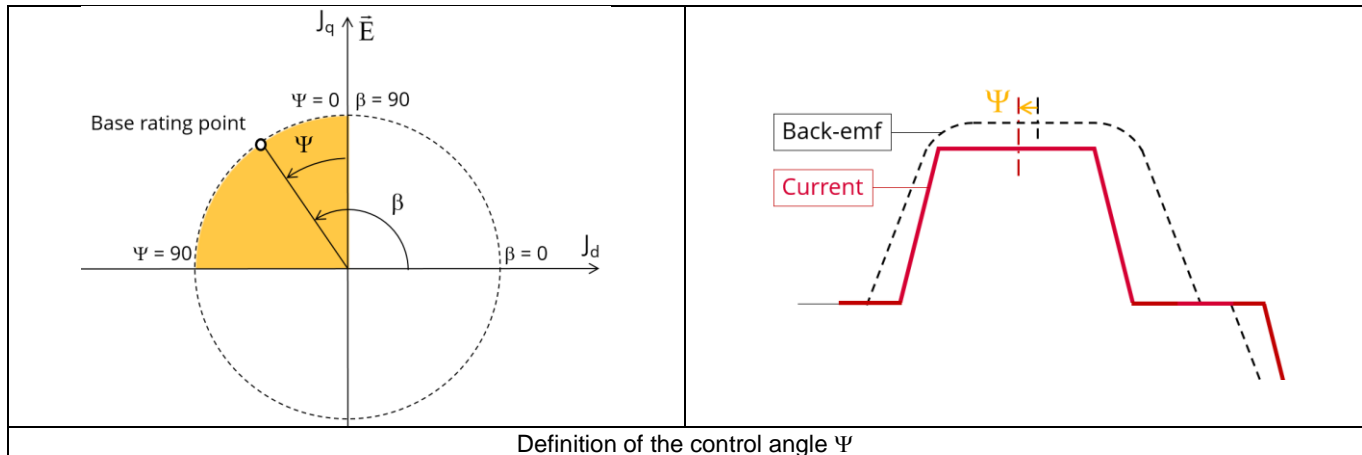

6.3.2.6 Conduction angle

The “**Conduction angle**” (*Electrical conduction angle*) is the time during which phase is powered with current.

The default value is 120 degrees (typical 6 steps control mode with a 6-transistor power electronics converter). It is an electrical angle. It must be set in a range of 0 to 180 degrees.

For more details refer to the following illustration “Conduction angle” and Rise and fall angle”.

6.3.2.7 Rise and fall angle

The “**Rise and fall angle**” (*Rise and fall angle of the current in electrical angle*) represents the time constant needed for current rise from 0 to the peak value of the current or current fall from the peak value to 0.

The default value is 6 degrees. It is an electrical angle. It must be set in a range of 0 to 90 degrees.

To be noted that the “Rise and fall angle” must be compatible with the “Conduction angle”. For instance, the “Rise and fall angle” must be strictly lower than half the value of “Conduction angle”. In any case, the addition of “Rise and fall angle” and the “Conduction angle” must be lower than 180 degrees.

For more details refer to the following illustration “Conduction angle” and Rise and fall angle”.

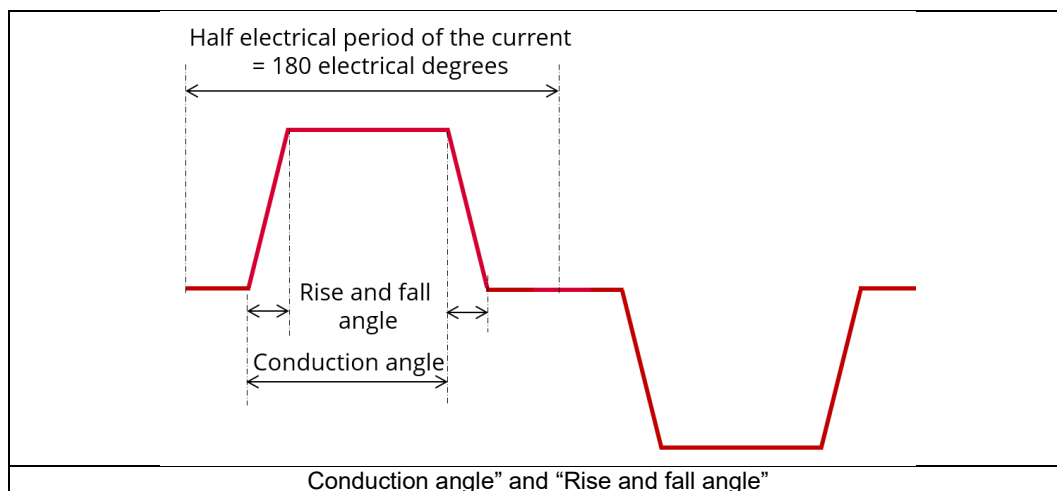

6.3.2.8 Iron loss computation

The “**Iron loss computation**” (*Iron loss computation: Yes / No*) allows to compute or not to compute the value of the iron losses in the magnetic circuit and display the corresponding losses versus time over an electric period.

The default value is “No”.

The iron losses will be computed on both stator and rotor parts.

Note 1: Iron losses are obtained through post-processing of finite elements analysis results (and not directly through the transient simulation), so to have a consistent power balance the useful torque is deduced from those losses.

Note2: This choice influences the computation time. So, the user can choose first computing the working point without iron loss results.

6.3.2.9 Losses in magnets computation

The “**Losses in magnets computation**” (*Losses in magnets computation: Yes / No*) allows to compute or not to compute the value of Joule losses in magnets and display them versus time over an electric period.

The default value is “No”.

If the user chooses to compute the losses in magnets, they are directly computed during the transient finite element simulation. It means that the obtained electromagnetic torque already takes them into account.

Notes: This choice influences the computation time. So, the user can choose first computing the working point without magnet loss results.

6.3.2.10 Additional losses

“Additional losses” input is not available in the current version (The input label is written in grey).

6.3.3 Advanced inputs

6.3.3.1 Minimum number of computations per electrical period

The user input “**Min. no. comp. / elec. period**” (*Minimum number of computations per electrical period*) influences the accuracy of results and the computation time. It allows giving a floor value for the number of computations per electrical period.

Note: In any cases, the real number of computations per electrical period will be higher because the number of computations within the rise and fall period is adjusted by FluxMotor® through an internal process. The distribution of computation points is illustrated below: Definition of the number of computations per electrical period.

The default value is equal to 87. The default value provides a good compromise between the accuracy of results and computation time. The minimum allowed value is 87.

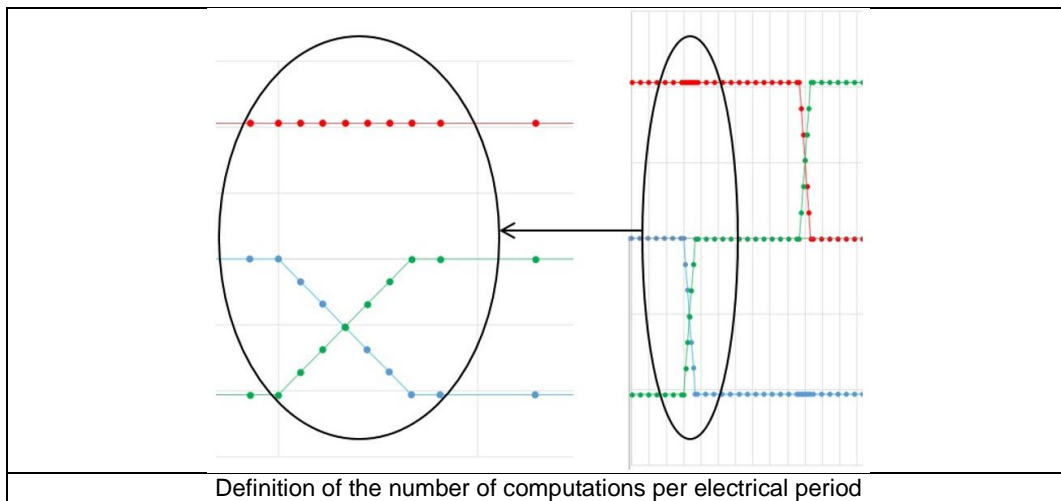

6.3.3.2 Rotor initial position

By default, the “**Rotor initial position**” is set to “**Auto**”.

When the “**Rotor initial position mode**” is set to “**Auto**”, the initial position of the rotor is automatically defined by an internal process of FluxMotor®.

The resulting relative angular position corresponds to the alignment between the axis of the stator phase 1 (reference phase) and the direct axis of the rotor north pole.

When the “**Rotor initial position**” is set to “**User input**” (i.e. toggle button on the right), the initial position of the rotor considered for computation must be set by the user in the field « **Rotor initial position** ». The default value is equal to 0. The range of possible values is [-360, 360].

For more details, please refer to the document: MotorFactory_SMPM_IOR_3PH_Test_Introduction – section “Rotor and stator relative position”.

6.3.3.3 Skew model – Number of layers

When the rotor magnets or the stator slots are skewed, the number of layers used in Flux® Skew environment to model the machine can be modified: “**Skew model - No. of layers**” (*Number of layers for modelling the skewing in Flux® Skew environment*).

6.3.3.4 Mesh order

To get the results, the original computation is performed using a Finite Element Modeling.

Two levels of meshing can be considered for this finite element calculation: first order and second order.

This parameter influences the accuracy of results and the computation time.

By default, second order mesh is used.

6.3.3.5 Airgap mesh coefficient

The advanced user input “**Airgap mesh coefficient**” is a coefficient which adjusts the size of mesh elements inside the airgap. When the value of “**Airgap mesh coefficient**” decreases, the mesh elements get smaller, leading to a higher mesh density inside the airgap and increasing the computation accuracy.

The imposed Mesh Point (size of mesh elements touching points of the geometry), inside the Flux® software, is described as:

$$\text{MeshPoint} = (\text{airgap}) \times (\text{airgap mesh coefficient})$$

Airgap mesh coefficient is set to 1.5 by default.

The variation range of values for this parameter is [0.05; 2].

0.05 giving a very high mesh density and 2 giving a very coarse mesh density.

Caution:

Be aware, a very high mesh density does not always mean a better result quality. However, this always leads to a huge number of nodes in the corresponding finite element model. So, it means a need of huge numerical memory and increases the computation time considerably.

6.3.4 Main principles of computation

6.3.4.1 Introduction

The aim of this test is to give a good overview of the electromagnetic potential of the machine when powered by a square wave current.

Several computation processes are involved:

- Working point
- Computation of iron losses
- Computation of magnet losses

6.3.4.2 Working point

The shape of the current is modelled by a parameterized trapezoidal profile.

Indeed, slopes are added on this square wave current to fit the reality, where a pure square wave current has no physical meaning (it would correspond to an infinite voltage).

The definition of the trapezoidal shape of the current is described on the following figure.

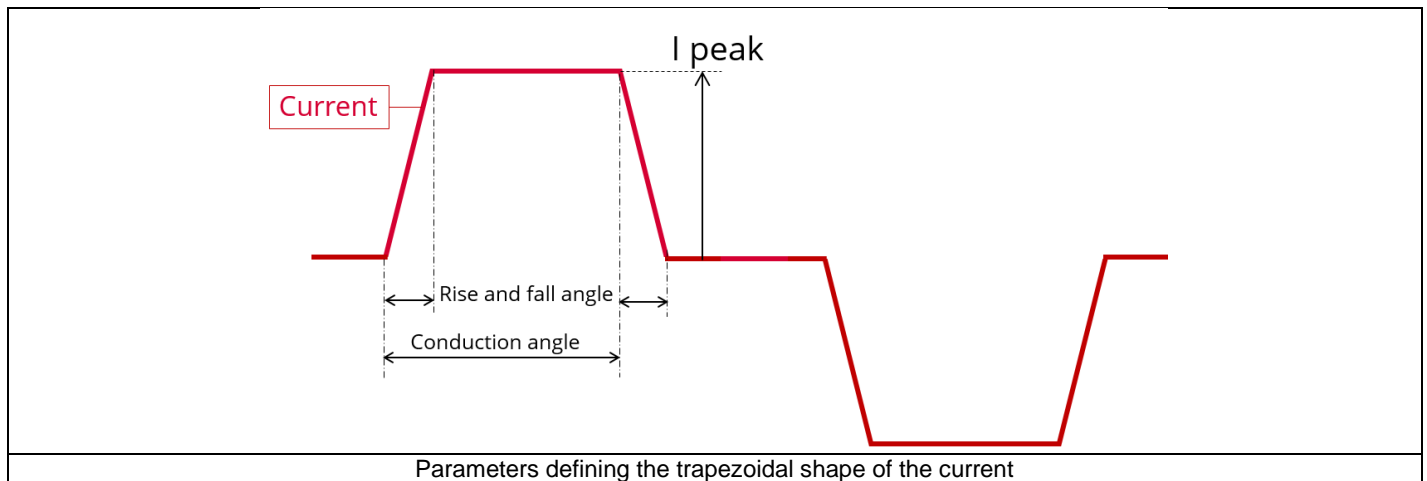

The principle of imposing the control angle in this test consists in positioning the magneto-motive force (MMF) according to the magnet axis already aligned and locked with d-axis of reference phase axis. The relative angular position between them is the targeted control angle. It can be easily illustrated by the following figure.

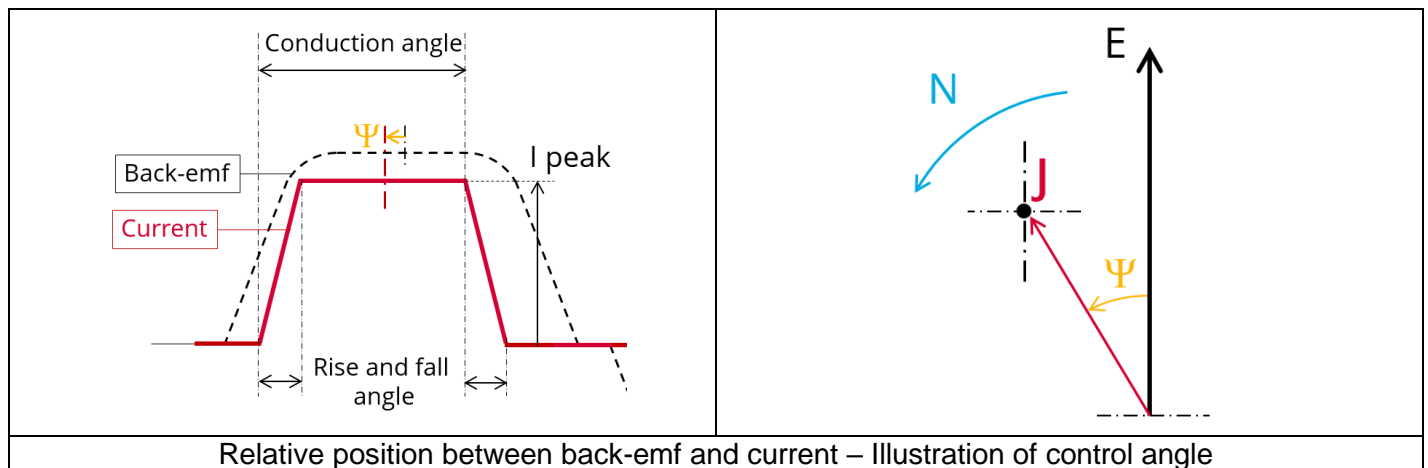

The two previous figures show the parameters defining the line current (I peak, control angle, speed, conduction angle, rise and fall angle). The resulting line current is then applied in a transient simulation (with the Finite Element Analysis software – Flux®): the phase current, the phase voltage, Line-Line voltage, the electromagnetic torque, useful torque, and the losses are outputs of this transient simulation.

The other features described in the overview are the results of other internal post processing of FluxMotor®.

6.3.4.3 Computation of iron losses

When requested by the user, a specific computation can be performed to determine the amount of iron losses for the rotor and stator magnetic circuits.

To perform it, “Yes” must be answered for the input: “**Iron loss computation**”).

This computation is performed over half electrical period by using Finite Element modelling. The reconstituted signal is displayed by FluxMotor®.

The calculation of the iron losses based on the Steinmetz’s model, is carried out by using the Transient Magnetic application with a Finite Element Analysis – Flux®.

6.3.4.4 Computation of magnet losses

When requested by the user, a specific computation can be performed to determine the level of Joule losses inside the magnets.

To perform it, “Yes” must be answered for the input: “**Losses in magnets computation**”).

This computation is performed over half electrical period by using Finite Element modelling. The reconstituted signal is displayed by FluxMotor®.

FluxMotor® internal process considers the speed and the topology of the machine to get accurate results.

The calculation of the Joule losses is carried out by using the Transient Magnetic application with the Finite Element Analysis – Flux®.

6.4 Test results

Once a test is finished, the corresponding results are automatically displayed in the central window.

6.4.1 Test conditions

6.4.1.1 Inputs

All the parameter values, belonging to standard inputs or advanced inputs are described in this section.

It shows the initial conditions considered for the test.

Here are the displayed subsections:

- Context
- Standard parameters
- Advanced parameters

For more information refer to the section 6.3 (User inputs).

6.4.1.2 Settings

All the settings dedicated to the test and dealing with the thermal are displayed in this section.

Here is the displayed subsection:

- Thermal
- Mechanics

6.4.1.3 Winding and magnet characteristics

All winding and magnet characteristics are displayed in the following subsections:

- Magnet characteristics
- Winding characteristics

For more details, please refer to the document: MotorFactory_SMPM_IOR_3PH_Test_Introduction – section “Machine characteristics”.

6.4.2 Main results

6.4.2.1 Machine performance – Working point

Output data displayed in the following subsections are described in section Working point – Sine wave – Motor. Here are the displayed subsections:

- General data
- Machine constants
- Power balance
- Iron losses
- Flux in airgap
- Flux density in iron
- Magnet behavior

For more details, please refer to the document: MotorFactory_SMPM_IOR_3PH_Test_Introduction – section Test generic information”.

6.4.2.2 Ripple mechanical torque

The analysis of the ripple torque is presented in the table “Ripple mechanical torque” with the following subsections:

- Working point

For more details, please refer to the document: MotorFactory_SMPM_IOR_3PH_Test_Introduction – section Test generic information”.

6.4.3 Curves

List of computed and displayed curves to illustrate the machine performance – Working point:

1) Normalized back-emf, phase currents and mechanical torque versus time – Working point

This curve is a synthesis showing the resulting torque obtained from the interaction between back-emf and phase current. For more visibility, the curves are normalized.

Note: The displayed torque corresponds to the electromagnetic torque because it must be compared with the current and the back-emf.

2) Phase voltage versus time – Open circuit

The curves of back-emf serve as reference for the control angle, and they also represent the phase voltages in case of no load.

3) Mechanical torque versus time – Working point

This graph shows the curves of electromagnetic and useful torques. In the case of no computation of magnet losses, the electromagnetic curve is the same as obtained (with the Finite Element Analysis software – Flux®) in transient Flux® simulation. Otherwise, the electromagnetic torque considers the losses in magnets.

The useful torque is the torque at the level of the motor shaft. Torques corresponding to Iron losses, mechanical and additional losses are subtracted from the electromagnetic torque to find the useful torque.

The curves of torque also illustrate the ripple torque. The main characteristics of the ripple torque are computed and displayed in the table of results.

4) Phase voltage versus time – Working point

The phase voltage curves give us the resulting voltage at coils terminals when the motor is supplied by the imposed current and when the rotor is rotating at the imposed speed.

In another point of view, they represent the necessary voltage to be imposed at the level of the coils to reproduce the conditions of the test.

5) Line-line voltage versus time – Working point

From a mathematic point of view, line-line voltages are compositions of phase voltages considering the winding connection. But from an electrical engineering point of view, line-line voltages represent the average voltage, the power electronic must supply to have the current described in the test inputs.

6) Phase current versus time – Working point

In square wave test, phase currents are deduced from the line currents. The winding connection is considered here: it means that in delta connection, even with square wave shape of the line currents supplied by the converter, the phase currents are results of the transient solving.

When windings are connected in wye, the phase currents are the same as line currents.

7) Line current versus time – Working point

The curves of line currents give an illustration of the inputs about the trapezoidal shape of the line currents.

8) Power versus time – Working point

The useful and absorbed powers are represented. The useful power is the available mechanical power at the level of motor shaft, and the absorbed power is the needed electrical power to be supplied to the motor to be compliant with the test conditions.

9) Losses versus time – Working point

In this graph, the involved losses are decomposed. They are obtained from transient simulation in Flux® and in other post-processing inside FluxMotor®.

Those losses are: Joule losses, iron losses, mechanical losses, additional losses and losses in magnets. The total losses are also displayed to facilitate power balance.