



ALTAIR

Altair[®] FluxMotor[®] 2023

Part Factory

General user information

Contents

1	Part Factory overview	4
1.1	Main areas of Part Factory	4
1.1.1	Overview	4
1.1.2	DESIGN area of the Part Factory application	5
1.1.3	TEST area of the Part Factory application	5
1.2	How to get into Part Factory?	6
1.2.1	Access to Part Factory is possible from Part Library by editing an existing part.	6
1.2.2	Access to Part Factory is possible from Part Library by creating a new part	7
2	Part data	8
2.1	Overview	8
2.2	Description of parts	9
2.2.1	Structural data	9
2.2.2	User parameters	9
2.2.3	Constraints	9
2.2.4	Status of parts	10
2.2.5	Details	11
2.3	Geometry building	12
2.3.1	Points	12
2.3.2	Lines	12
2.3.3	Faces and regions	13
2.3.4	Interface gaps	14
2.3.5	Parametric data	15
2.4	Slot physical properties	16
2.4.1	Example	16
2.4.2	List of possible elementary regions for an outer slot.	16
2.5	Bar physical properties	17
2.5.1	Example	17
2.5.2	List of possible elementary regions for an inner bar.	17
2.6	Magnet physical properties	18
2.6.1	Example	18
2.6.2	List of possible elementary regions for an inner magnet.	19
2.7	Saliency physical properties	20
2.7.1	Example	20
2.7.2	List of possible elementary regions for an inner saliency.	20
2.7.3	Rotor D-Axis location	21
2.8	Dimensions on drawing	23
3	DESIGN	24
3.1	Overview	24
3.2	Expanding the menu in Part Factory	25
4	TEST	26
4.1	Overview	26
4.2	Simulate	27

4.2.1	Import a part in Motor Factory	27
4.2.2	Modify the structural data	28
4.2.3	Modify user input parameters	29
5	System functions	30
5.1	Overview	30
5.2	User actions	31
5.2.1	Export python and parametric python	31
5.2.2	Debug mode function	32
5.2.3	Exit	32

1 PART FACTORY OVERVIEW

1.1 Main areas of Part Factory

1.1.1 Overview

To build a machine, parts are needed. Three main families of parts can be considered: the slots, the magnets and the bars. All the properties needed to build a part are defined and written in dedicated Excel files. The process to build them is about the same. All the basic parameters are listed below.

Part Factory is a dedicated application to allow the creation or the modification of parts, i.e. the customization of parts.

Part Factory consists of two main areas:

- The DESIGN area to visualize and modify the properties of parts
- The TEST area to evaluate the relevance and the robustness of the part being built.

To reach one of these areas just click on the corresponding button.

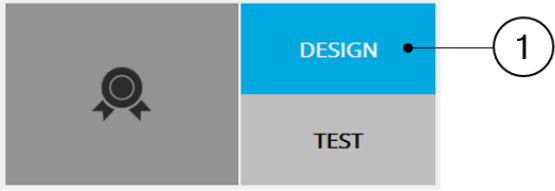
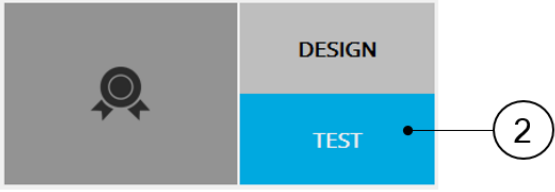
	1	Get into the DESIGN area of Part Factory.
	2	Get into the TEST area of Part Factory.

1.1.2 DESIGN area of the Part Factory application

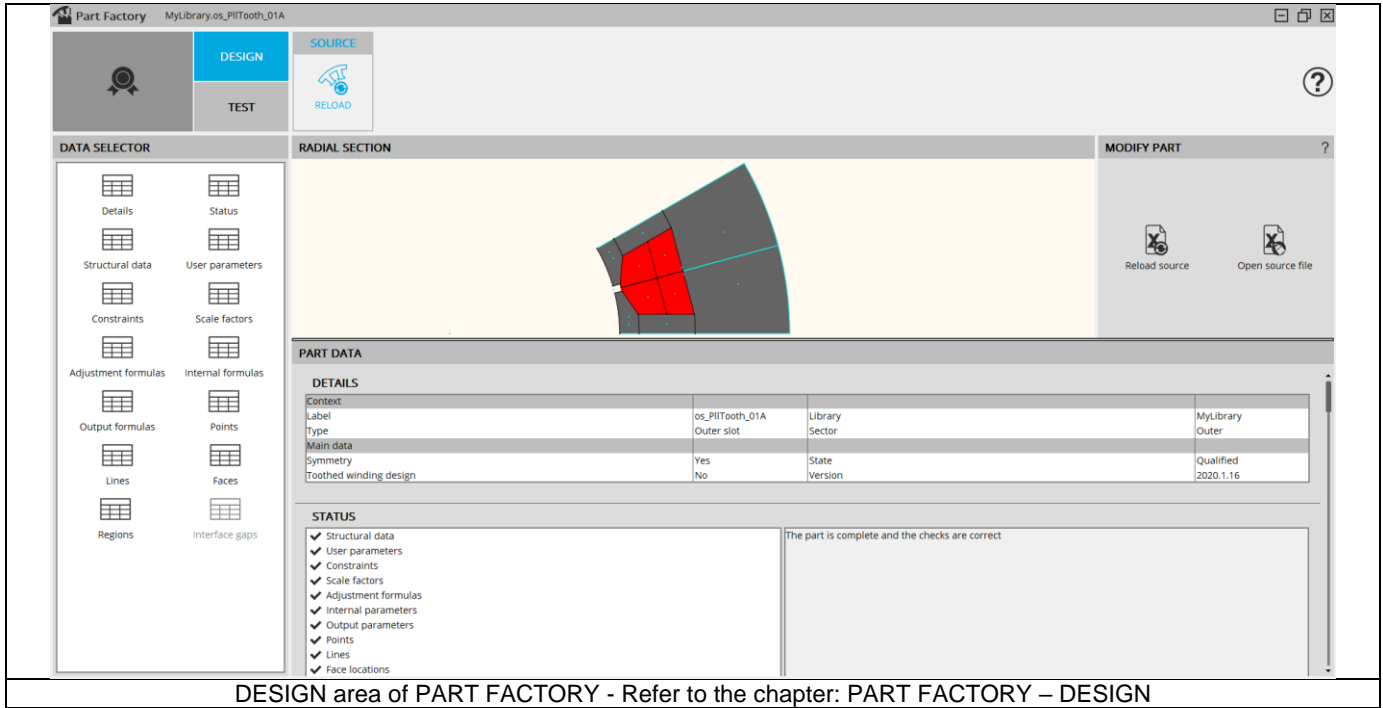

1.1.3 TEST area of the Part Factory application

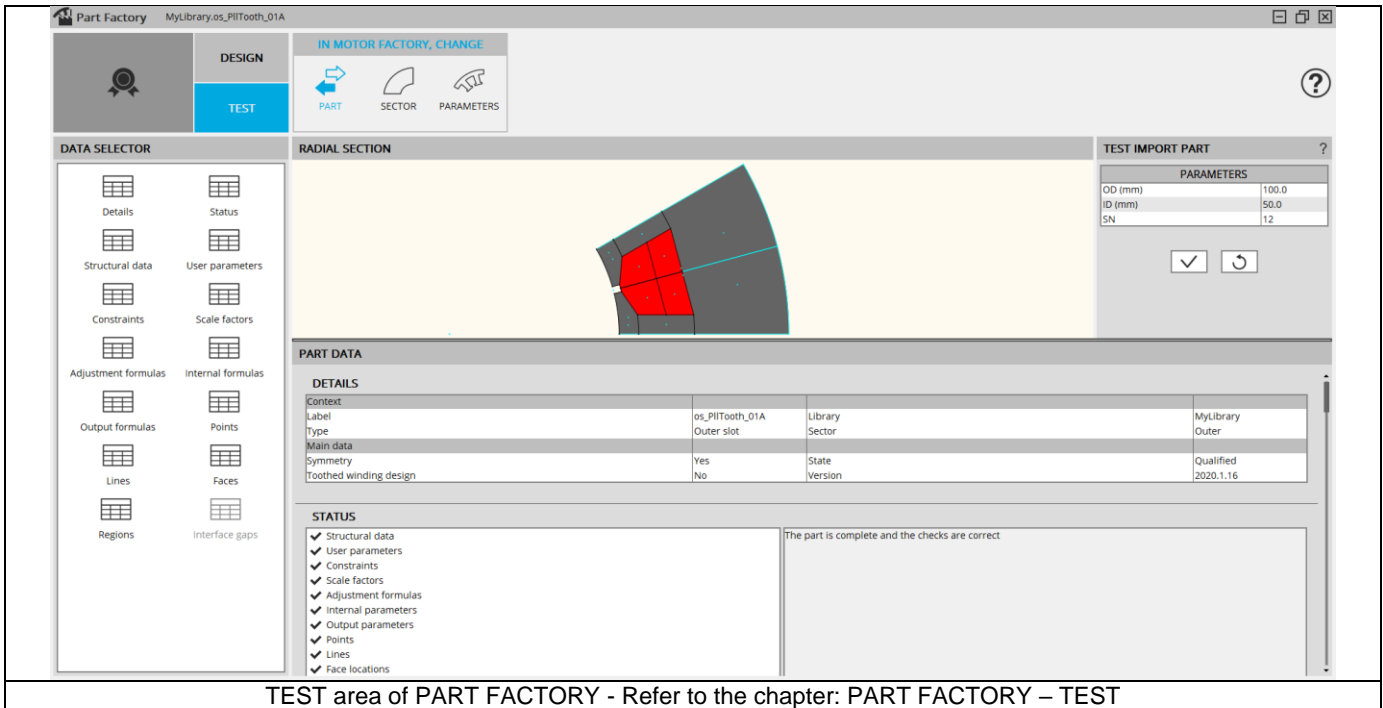

1.2 How to get into Part Factory?

Two ways are possible:

- From Part Library, by editing a part.
- From Part Library by creating a new part

1.2.1 Access to Part Factory is possible from Part Library by editing an existing part.

Altair® FluxMotor® allows the user to design parts and add them to Part Libraries.

This can be done by starting from a part given in FluxMotor® which is close to the shape to be designed.

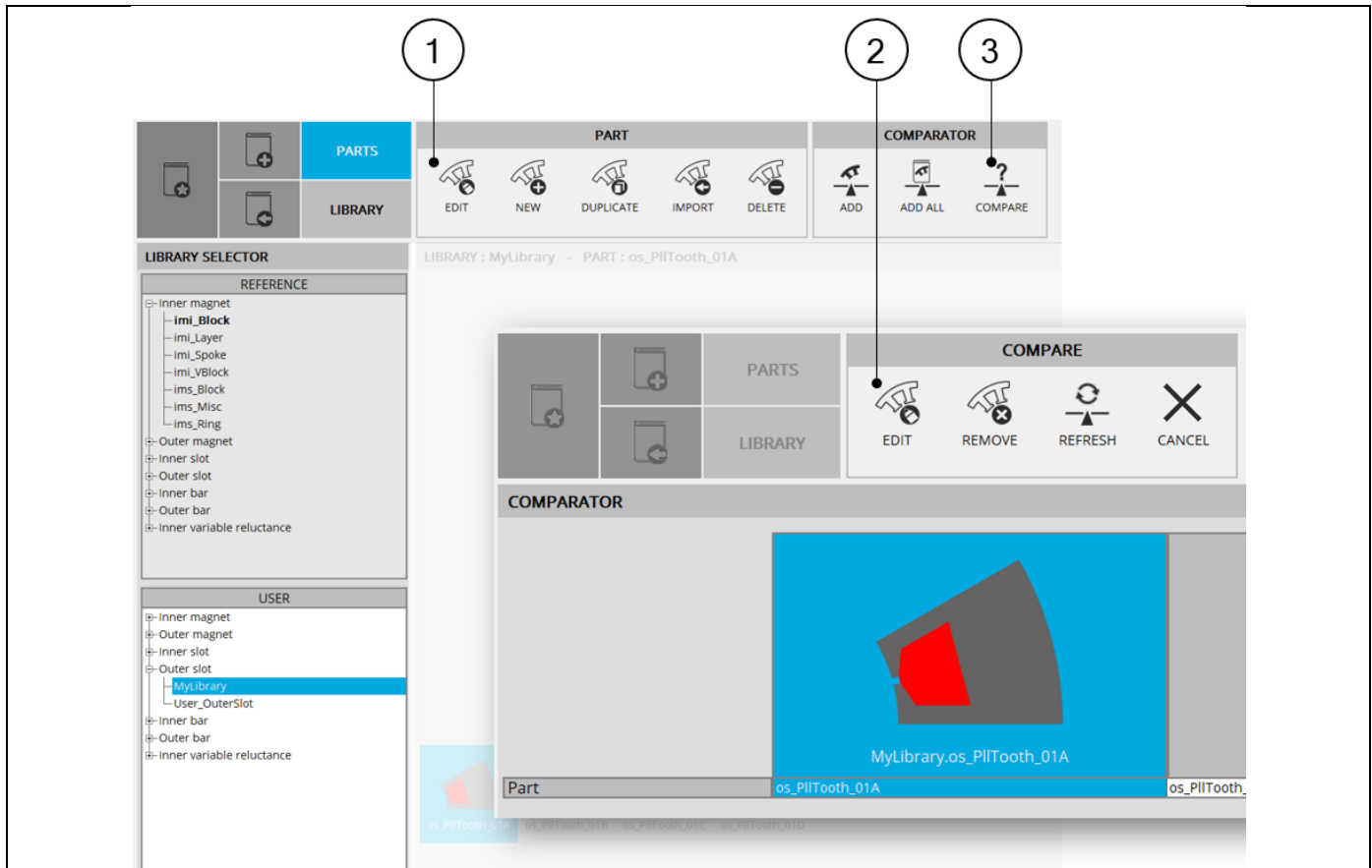
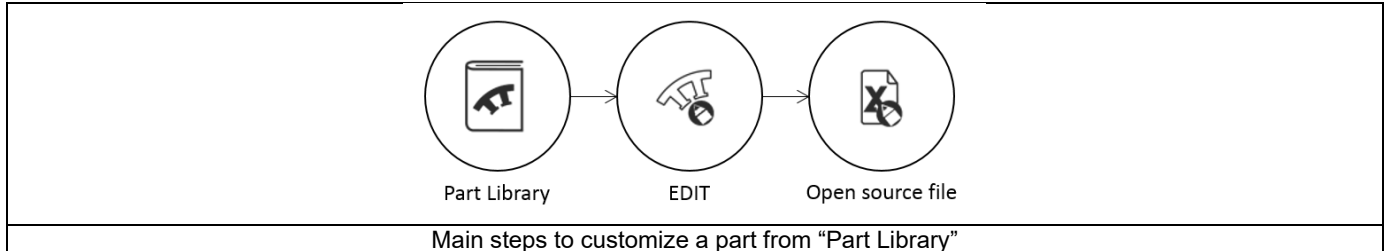

How to get into Part Factory from Part Library - EDIT a part

1	Editing a Part from the PARTS area of the Part Library allows getting into Part Factory. See Part Library help documentation for more details.
2	Editing a part is possible by accessing to the comparator (3) from the PARTS area of the Part Library. This editing of a selected part allows to get into Part Factory. See Part Library help documentation for more details.

1.2.2 Access to Part Factory is possible from Part Library by creating a new part

FluxMotor® allows the user to design parts and add them to Part Libraries.

This can be done by creating a part from scratch, using the reference file corresponding to the type of part to create (Inner Magnet, Outer Slot, etc.).

In Part Library, it is possible to create a new part by selecting an Excel file in which all the parameters of the part to create are defined. See section Part Library.

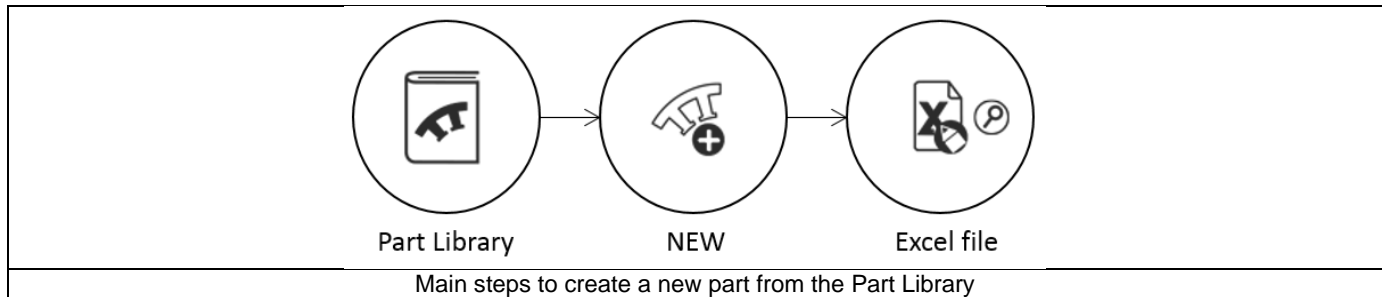

The screenshot shows the FluxMotor software interface. The top menu bar includes 'PARTS' and 'LIBRARY'. The 'PART' menu is open, showing options: EDIT, NEW (circled with '1'), DUPLICATE, IMPORT, and DELETE. The 'COMPARATOR' menu is also visible with options: ADD, ADD ALL, and COMPARE. The main workspace displays a 'LIBRARY : MyLibrary - PART : os_PllTooth_01A' view. On the left, there is a 'LIBRARY SELECTOR' with 'REFERENCE' and 'USER' sections. A 'Creating a part' dialog box is open, showing fields for 'Name: *' and 'Excel file: *' (circled with '2'). The dialog box has 'OK', 'Cancel', and 'Help' buttons. Below the dialog box, there are four thumbnails of parts: os_PllTooth_01A, os_PllTooth_01B, os_PllTooth_01C, and os_PllTooth_01D.

Click on the icon "NEW" (1) to create a new part and select the corresponding Excel file (2) to get into Part Factory with the considered part.

2 PART DATA

2.1 Overview

Different types of parts are considered like for instance outer slot and inner magnet.

Outer slots are defined in the outer ring of the machine and inner magnets are defined in the inner ring of the machine. Each of them is described into a sector, as shown in the picture below.

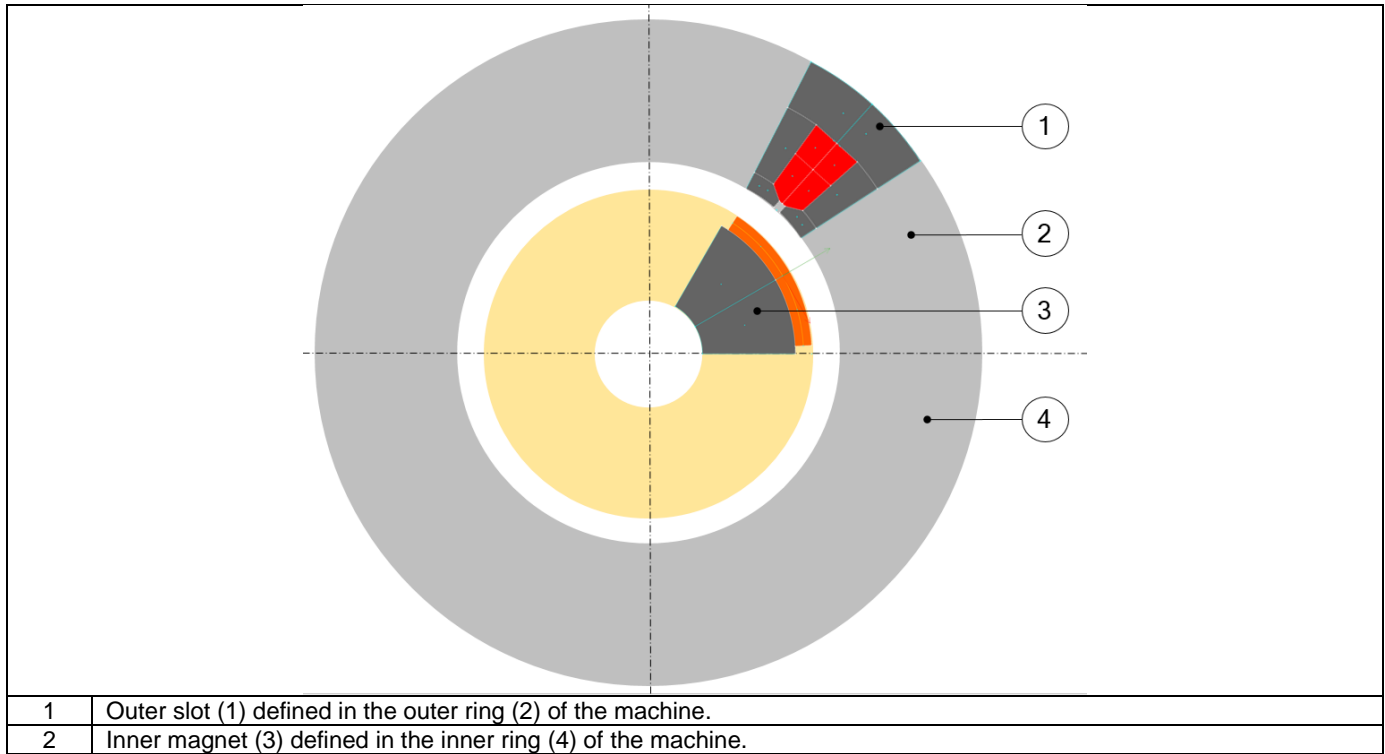

2.2 Description of parts

2.2.1 Structural data

The parts are created and described in each sector and are defined by:

- Inner diameter of the sector
- Outer diameter of the sector
- Slot number or magnet number, driving the angular opening of the sector.

This information is called structural data of the part. See the illustration of the sector shown below.

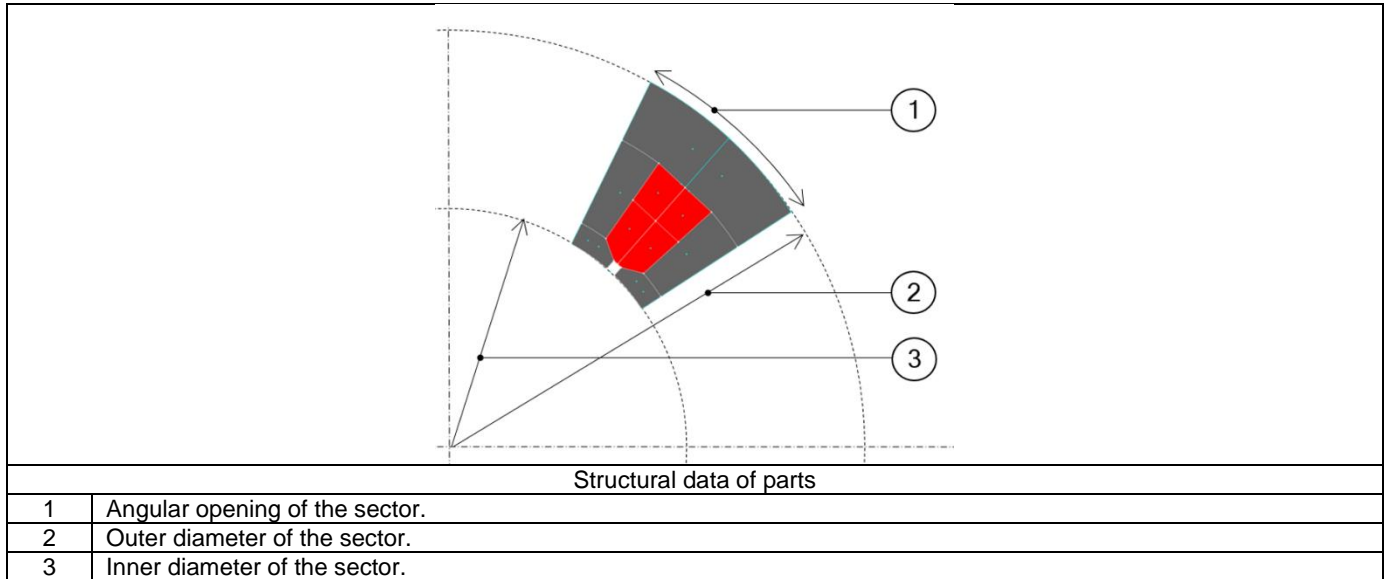

2.2.2 User parameters

All the parts can be parameterized so that the dimensions can be modified by using user parameters. These dimensions of the part are defined inside the sector (that is by considering the structural data).

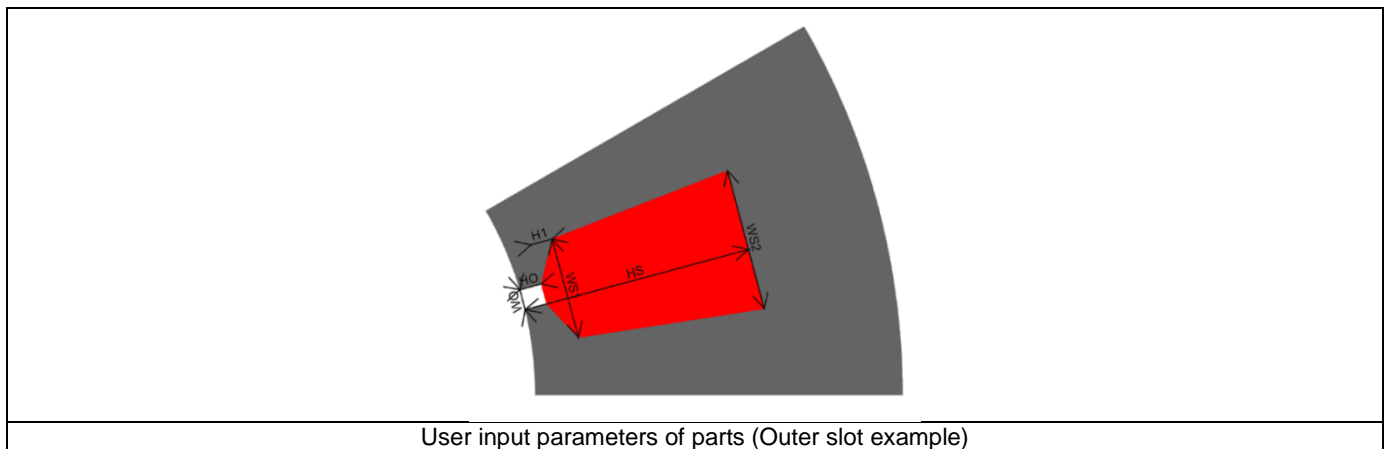

Note: A section "Output formulas" allows defining additional information about dimensions of the considered part. So, the output data defined is displayed in Motor Factory DESIGN area for SLOT or MAGNET.

2.2.3 Constraints

Constraints can be imposed in a part to control the use of user input parameters. For example, a slot height cannot be greater than the thickness of the stator outer ring. This is mainly to improve the robustness of parts.

Note: Constraints are not mandatory in parts definition.

2.2.4 Status of parts

The status of a part illustrates the building steps of the part that have been carried out. It validates that the considered part can be used to build a machine (in Motor Factory).

1	2
<ul style="list-style-type: none"> ✓ Structural data ✓ User parameters ✓ Constraints ✓ Scale factors ✓ Adjustment formulas ✓ Internal parameters ✓ Output parameters ✓ Points ✓ Lines ✓ Face locations ✓ Checkers 	<ul style="list-style-type: none"> ✓ Structural data ✓ User parameters ✓ Constraints ✓ Scale factors ✓ Adjustment formulas ✓ Internal parameters ✗ Output parameters ✗ Points ✗ Lines ✗ Face locations ✗ Checkers
<p>Example of status:</p> <p>1) On the left side, all the steps are validated, and the part can be used in Motor Factory</p> <p>2) On the right side, the part is not yet finished and cannot be used in Motor Factory</p>	

When all the items of the status are not validated, then it is illustrated in the list shown above, but some icons are also modified as indicated below.

	<p>os_Free_01A</p>	<p>ims_Ring_01D</p>
<p>How is it shown that the considered part is not validated and cannot be used in Motor Factory?</p>		
1	The icon on the right top part of the Part Factory environment shows a broken illustration.	
2	Thumbnail to illustrate a non-validated outer slot.	
3	Thumbnail to illustrate a non-validated inner magnet.	

	1
	2
<p>Illustration of invalid part for inner magnet (1) or outer slot (2)</p>	

2.2.5 Details

The parts data are grouped in a section and named as “Details”. Information is given as:

- Name of the part
- Name of the corresponding library
- Type of library
- Type of sector
- State (Qualifiable or Not qualifiable)
- Version of the model used to build the parts in Part Factory.

Other information such as toothed winding design or consequent pole depend upon whether it is a slot or magnet.

2.3 Geometry building

The basic elements needed to build a part are the points, the lines, the faces and the regions.

2.3.1 Points

This section contains the coordinates of all points needed to build the part. These coordinates are written by considering Cartesian coordinate system and Polar coordinate system.

Below are the examples of coordinate systems for the description of slots (Symmetric or non-symmetric). The same principle is also used for magnet.

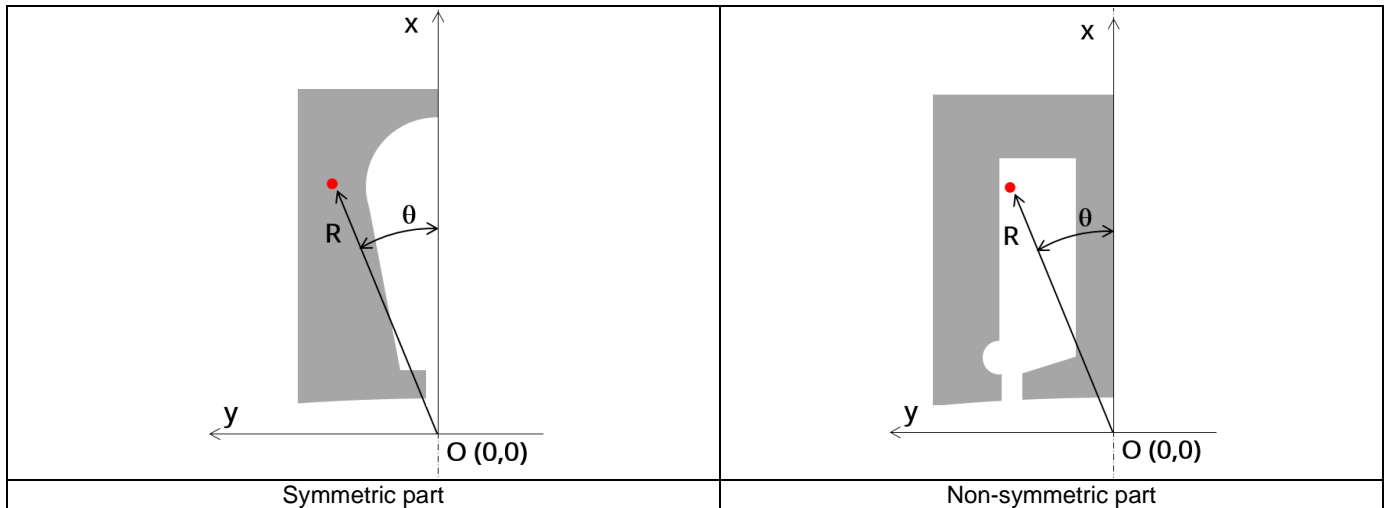

The visibility property of points can be made as “Visible”, “Invisible” or “Not exist”.

- Visible, to be used by visible and invisible lines
- Invisible, to be used by invisible lines
- No exist, for arc centers

All the visible points must belong to a sector.
Superimposed points are forbidden.

2.3.2 Lines

This section contains the description of all the lines used in the part model.
Lines only depend on points and sector points

Two types of lines exist:

- Segment (straight lines defined with only two extremity points)
- Arc (defined in Counter Clockwise direction, with starting, ending and center points)

The visibility property of lines can be “Visible”, “Invisible” and “No exist”.

- “Visible” to separate two faces having different properties (faces with different natures, lines separating coil conductor regions in 4 zones for adjacent and superimposed winding for example or for lines separating the airgap from the stator or the rotor etc.).
- “Invisible” when lines have not to be considered in the “part” model. An invisible line won’t be represented in the finite element model of the part.
- “No exist” when the corresponding line will be used as a support to illustrate the polarization of magnets for example. A “No exist” line will be neither used to build the geometry of the part nor to represent in the finite element model of the part.

Note: The length of each line defined in the geometry is indicated.

Be aware that when the length of a visible line is very small it can lead to a model with a huge number of elements (Finite Element modeling being at the heart of FluxMotor®). In this case the computation times can be very long.

2.3.3 Faces and regions

This section contains the description of all the faces and regions defined and used in the part model.

Each face is defined by a location point. The coordinates of these points are defined in a general coordinate system (Cartesian or polar) as it is described above for points.

The point must be within the corresponding face for all the values of user input parameters. Each face has a label and a nature. The nature of faces defines the corresponding regions.

The physical properties of regions are linked to the materials that can be used to build them. The table below gives the physical properties of slots and magnets.

Physical properties of regions						Families of materials associated to the part regions					
Type of Part	Group of regions	Elementary region	Number of allowed regions per part	Number of allowed elementary faces per region	Mandatory	Lamination	Solid	Magnet	Electric conductor	Electric insulator	Fluid (Gaz & Liquid)
Slot	Active Part	Coil Conductor	1	2 (Symmetric) or 4 (non-symmetric)	Yes				Yes		
		Magnetic circuit	Tooth	1	multi	Yes	Yes	Yes			
	Yoke		1	multi	Yes	Yes	Yes				
	Tooth foot		1	multi	Yes	Yes	Yes				
	#	Insulating wedge	1	multi	No					Yes	
	#	Fluid area	1	multi	No						Yes
	#	Fluid intercoil	1	2	No						Yes
#	Insulator intercoil	1	2	No					Yes		
Magnet	Active Part	Magnet	multi	1	Yes			Yes			
		Magnetic circuit	Yoke	1	multi	Yes at least 1	Yes	Yes			
	Web		1	multi	Yes		Yes				
	Bridge		1	multi	Yes		Yes				
	Pole core		1	multi	Yes		Yes				
	Pole shoe		1	multi	Yes		Yes				
	Interpole		1	multi	Yes		Yes				
	#	Hub	1	multi	No		Yes				
#	Edge	1	multi	No						Yes	
Bar	Active Part	Solid Conductor	multi	1	Yes				Yes		
		Magnetic circuit	Tooth	1	multi	Yes	Yes	Yes			
	Yoke		1	multi	Yes	Yes	Yes				
	Tooth foot		1	multi	Yes	Yes	Yes				
#	Fluid area	1	multi	No						Yes	
Saliency	Magnetic circuit	Yoke	1	multi	Yes	Yes	Yes				
		Web	1	multi	No	Yes	Yes				
		Bridge	1	multi	No	Yes	Yes				
		Pole core	1	multi	No	Yes	Yes				
		Pole shoe	1	multi	No	Yes	Yes				
		Interpole	1	multi	No	Yes	Yes				
	#	Flux barrier	multi	1	No						Yes
#	Hub	1	multi	No		Yes					
#	Edge	1	multi	No						Yes	
Slot, Bar, Magnet or Saliency	#	Hole	1	multi	No						Yes
	#	Slit	1	multi	No						Yes
	#	Cooling hole	multi	1	No						Yes
	#	Mechanical device	multi	1	No		Yes				
	#	Ferromagnetic wedge	1	multi	No		Yes				

Physical properties of regions and associated materials

Note 1: When the regions are grouped (See group of regions above) the same material is associated to all the regions grouped.

Note 2: The possible materials associated to the regions shown above can help user to see the meaning of elementary regions.

Note 3: The areas of each face and each region defined in the geometry are indicated in the sections dealing with FACES and REGIONS in Part Factory.

2.3.4 Interface gaps

"Interface gaps" regions allow describing thin regions between faces inside the topology of parts. It can be needed for example, to represent the glue layer or a very thin airgap between two ferromagnetic regions. This specific region is associated to a line which is visible. The thickness of the gap must be defined. Note: The physical property of interface gap is always air.

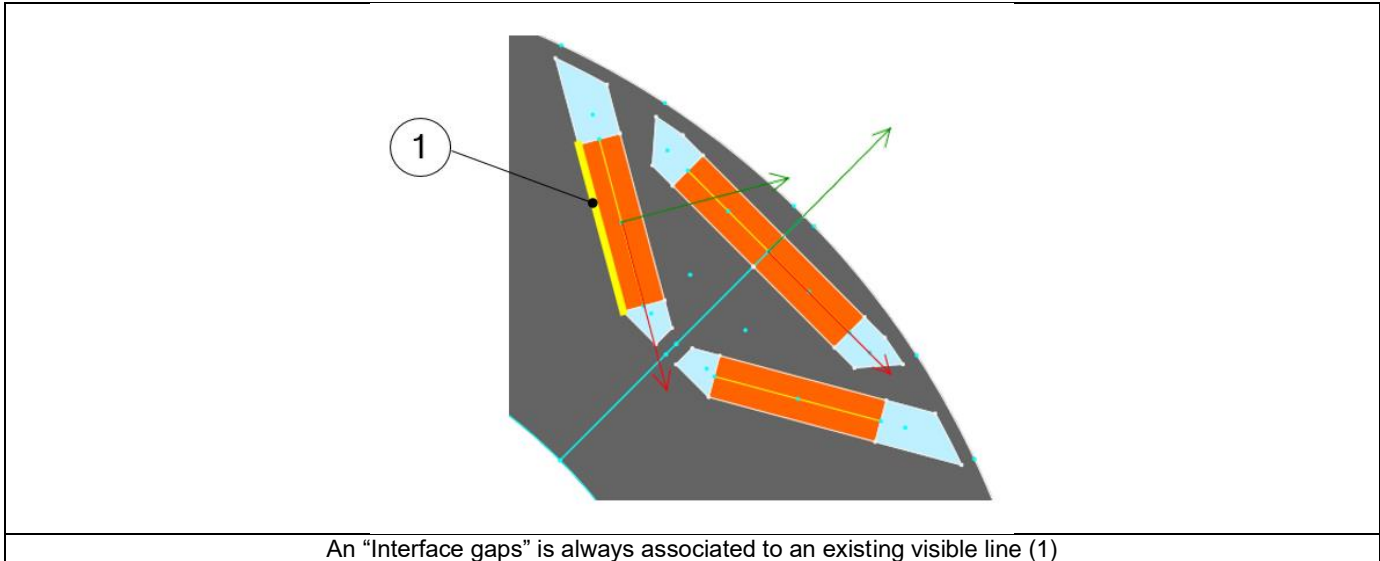

2.3.5 Parametric data

The part topology can be parameterized. Dedicated sections are provided to allow user to manage this according to the need. One section to do this is called “Internal formulas”. It allows describing all the needed formulas or expressions to define the part topology from user input parameters.

Two other sections, “Scale factors” and “Adjustment formulas” can be used when the considered part has the capability to adapt itself automatically to the sector in which it will be imported.

Let us take for example a part (Slot) defined in a sector where the structural data is as follows:

- Outer diameter = 100
- Inner diameter = 50
- Number of slots = 12

What will happen if this part is imported in a machine where then stator structural data is as follows:

- Outer diameter = 1000
- Inner diameter = 750
- Number of slots = 90

The aim of these two sections is to define transformation formula which allows an automatic adaptation of the part when it is imported in a new sector with differences between original and final structural data.

A dedicated tutorial is provided to explain the principles for applying these rules.

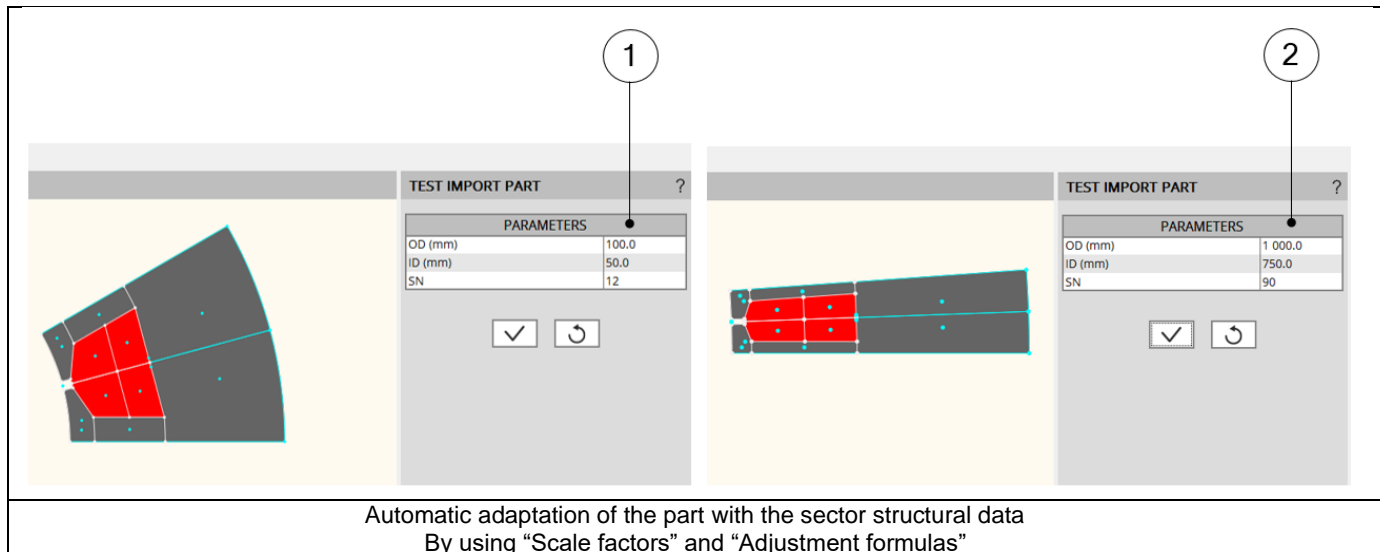

2.4 Slot physical properties

2.4.1 Example

Here is an example of regions in outer slot. Note that the same principles apply to inner slot.

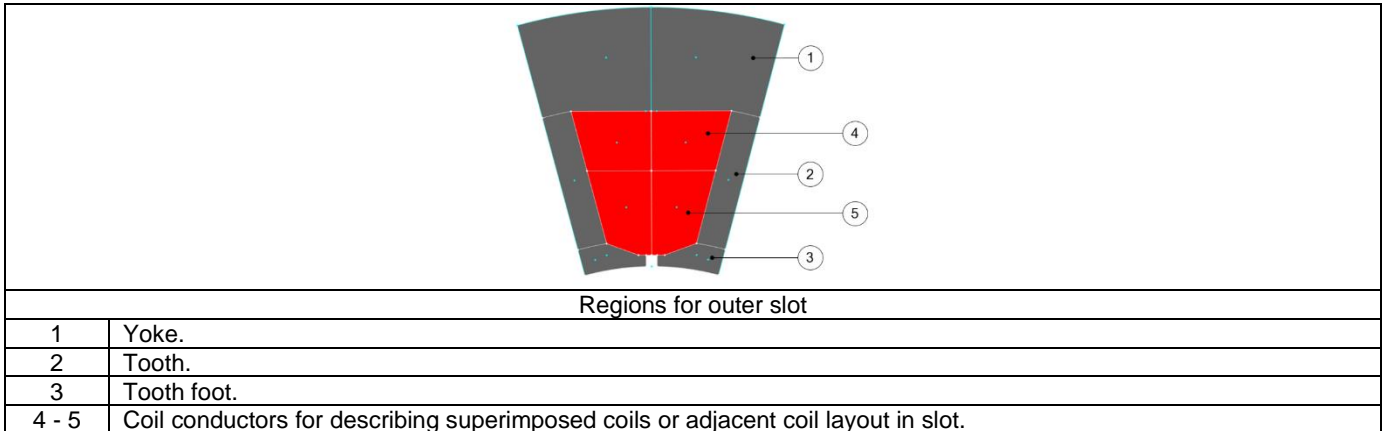

2.4.2 List of possible elementary regions for an outer slot.

- Coil conductor, Tooth, Yoke and Tooth foot illustrated above.
- Insulating wedge or Ferromagnetic wedge

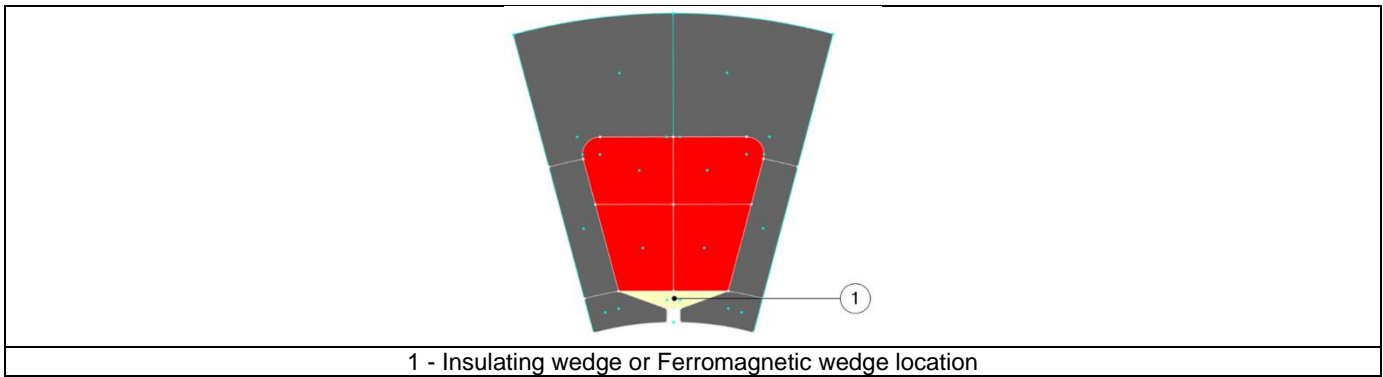

- Fluid “Intercoil” or Insulator “Intercoil” dedicated to tooth winding design.

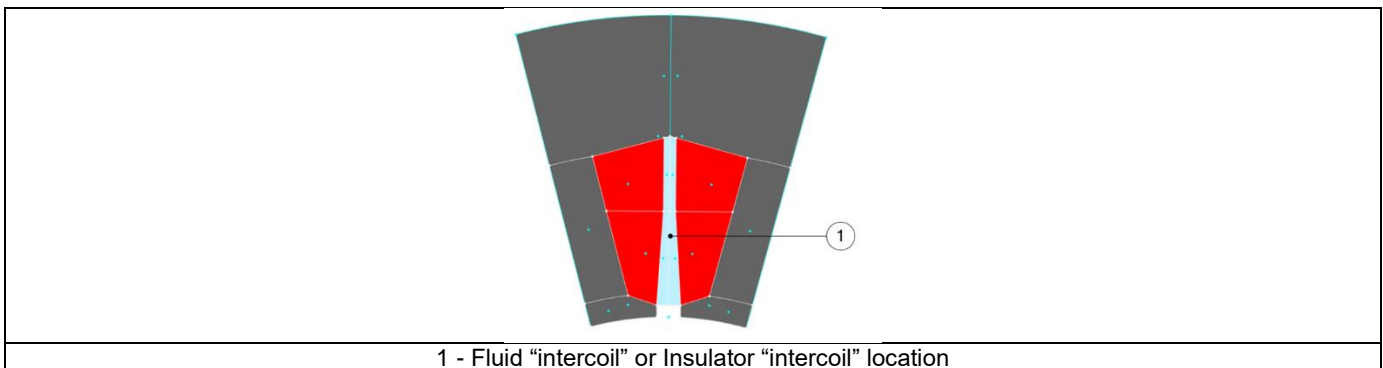

- Mechanical device to represent rivet for example
- Fluid area
- Hole or Slit
- Cooling hole

2.5 Bar physical properties

2.5.1 Example

Here is an example of regions in inner bar. Note that the same principles apply to outer bar.

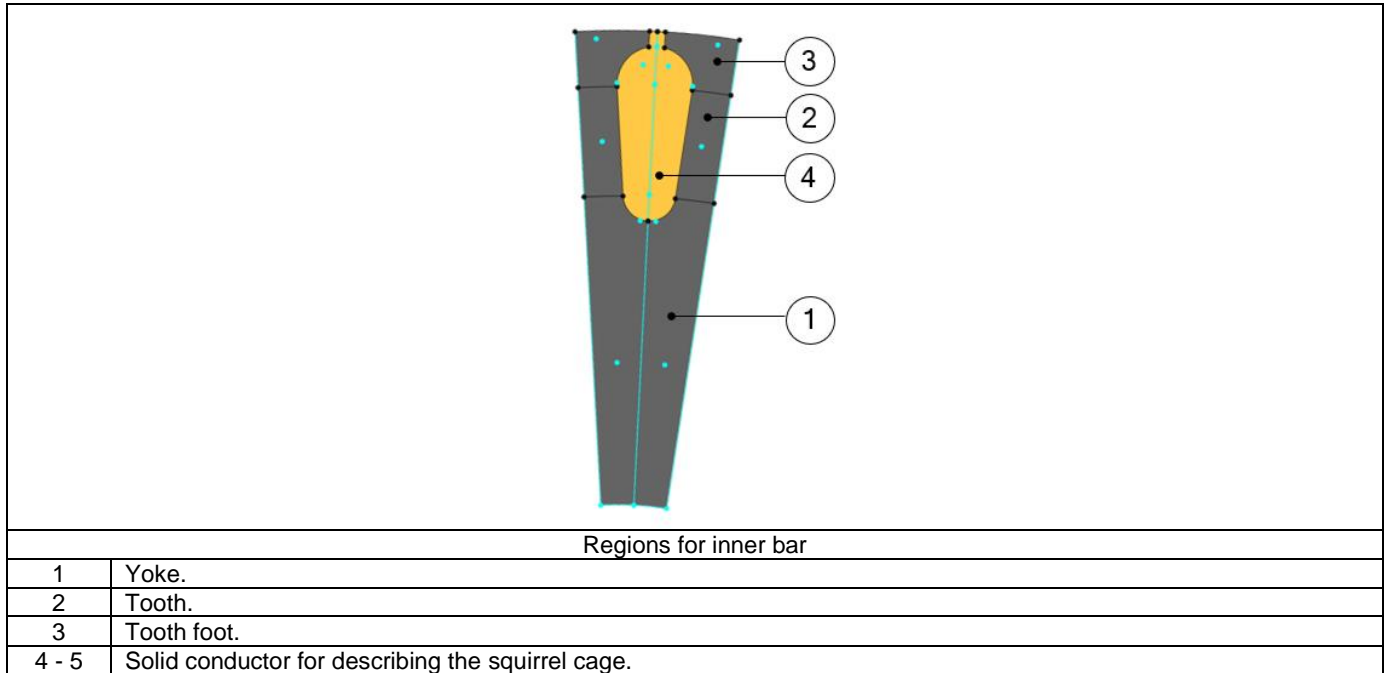

2.5.2 List of possible elementary regions for an inner bar.

- Solid conductor, Tooth, Yoke and Tooth foot illustrated above.
- Ferromagnetic wedge
- Mechanical device to represent rivet for example
- Fluid area
- Hole or Slit
- Cooling hole

2.6 Magnet physical properties

2.6.1 Example

Here is an example of regions in inner magnet. Note that the same principles apply to outer magnet.

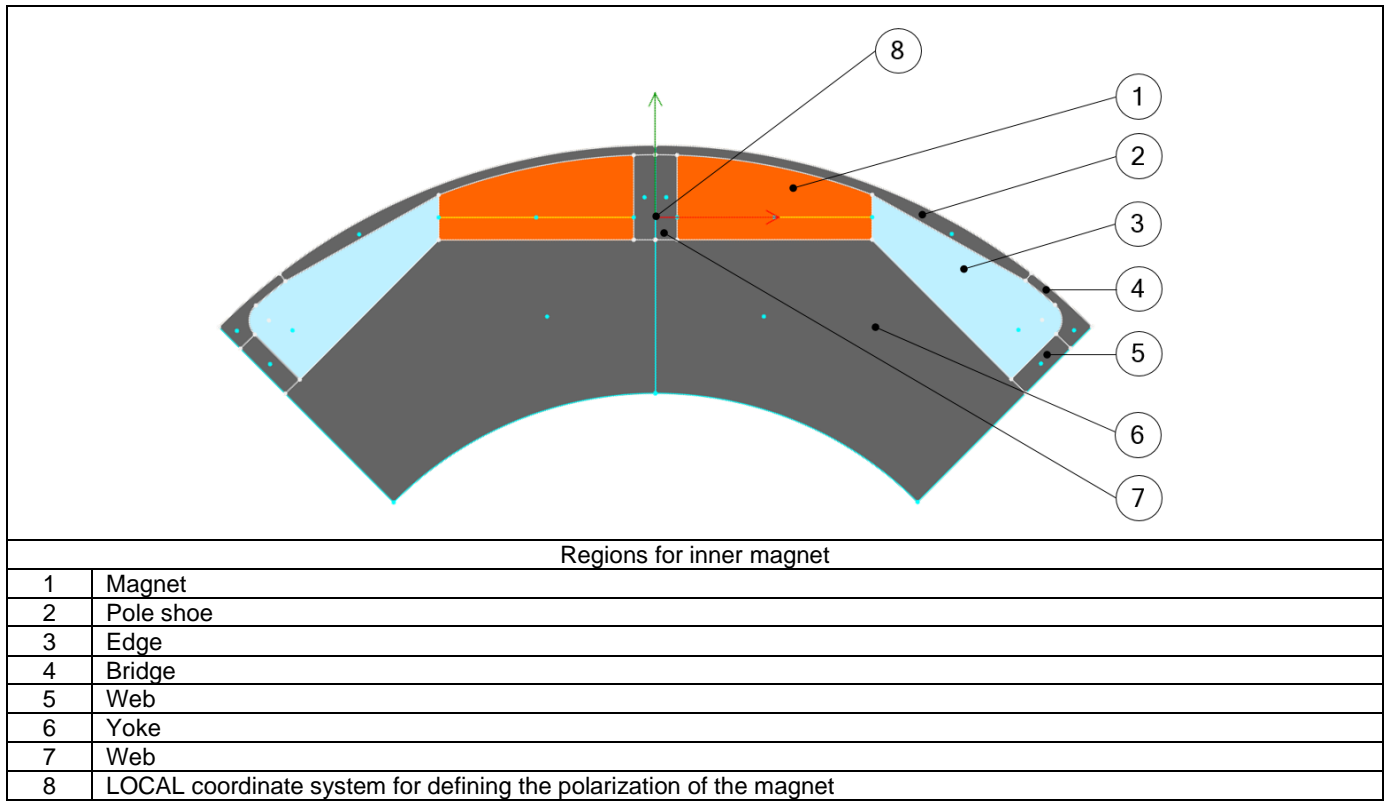

A coordinate system is dedicated to magnet. This is what we call the LOCAL coordinate system. It is used to define the magnet's polarization.

Notes:

- 1) By default, a GLOBAL coordinate system is defined. Its reference point is located at the center of the rotor.
- 2) For spoke magnets, the coordinate system defining polarization must be along the symmetry axis. Otherwise the polarization will not be consistent.

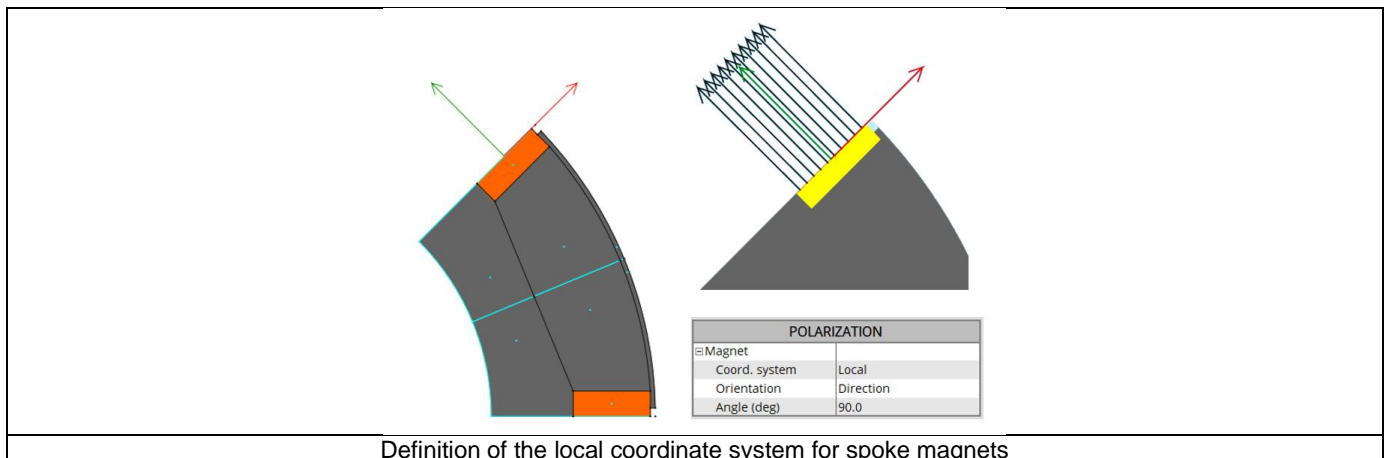

Definition of the local coordinate system for spoke magnets

2.6.2 List of possible elementary regions for an inner magnet.

- Magnet, Pole shoe, Edge, Bridge, Web, Yoke is illustrated above.
- Pole core, Interpole or Hub

Description of different ferromagnetic zones in magnetic circuit associated with magnet.

- Hole or Slit

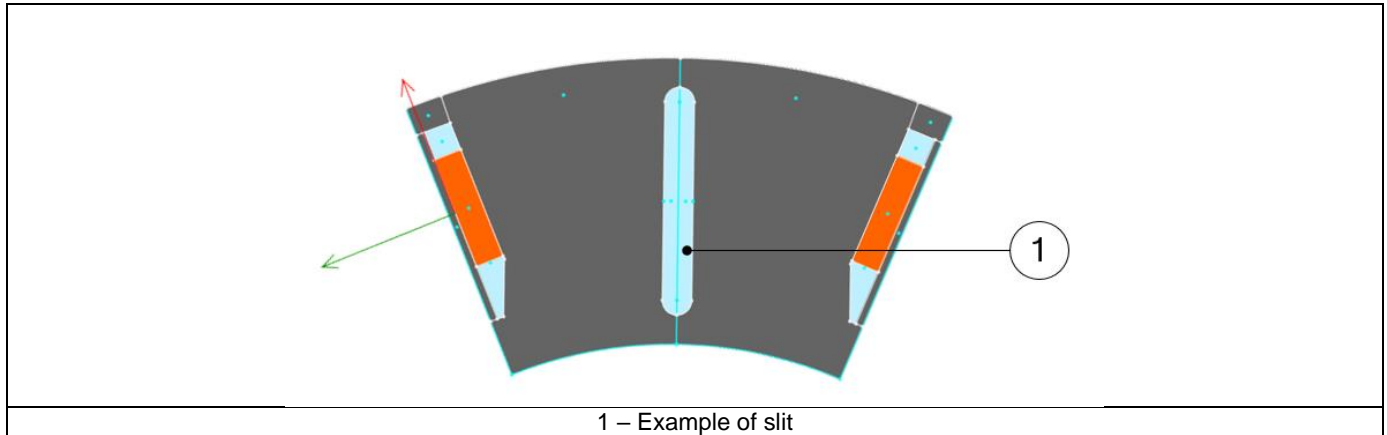

- Cooling hole
- Mechanical device to represent rivet for example
- Ferromagnetic wedge

2.7 Saliency physical properties

2.7.1 Example

Here is an example of regions in inner saliency.

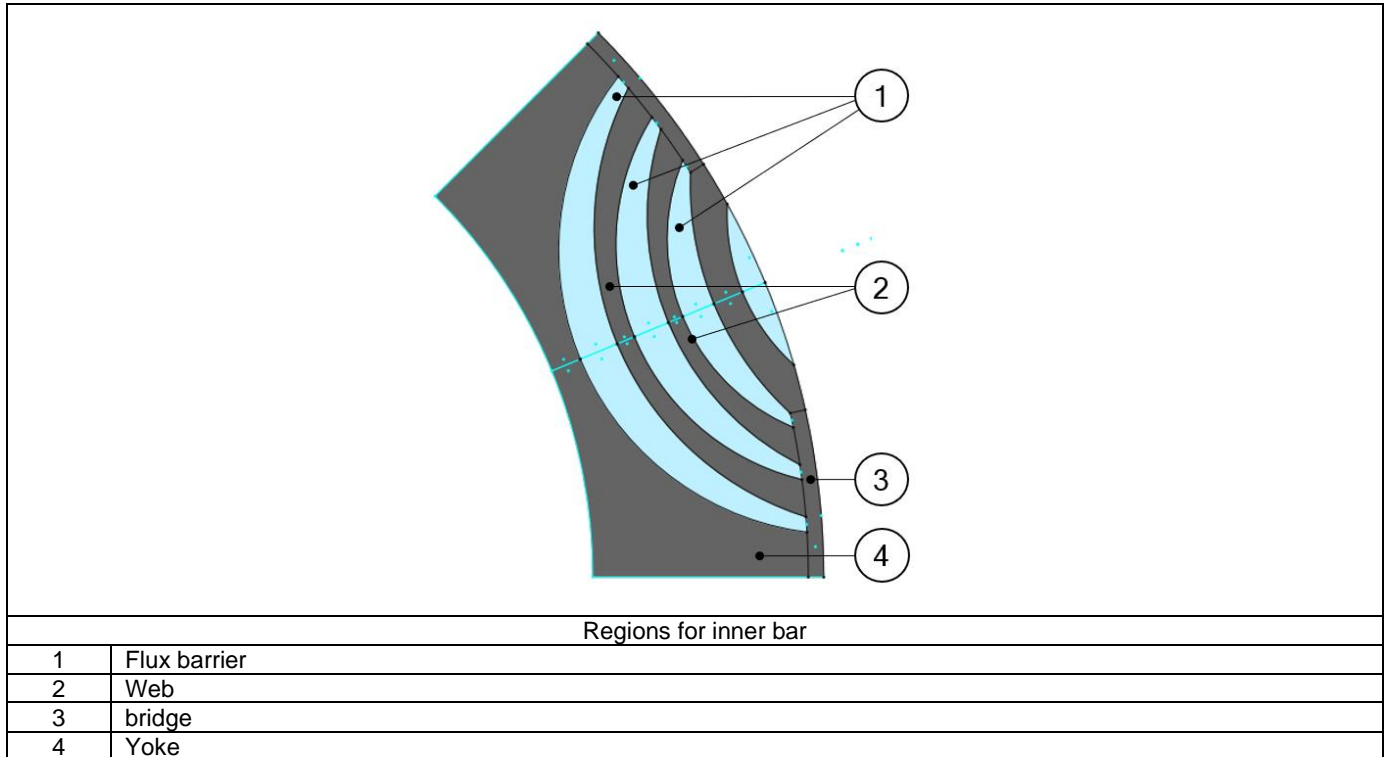

2.7.2 List of possible elementary regions for an inner saliency.

- Yoke, web, bridge, pole core, pole shoe, interpole
- Flux barrier, hub, edge
- Mechanical device to represent rivet for example
- Ferromagnetic wedge
- Hole or Slit
- Cooling hole

2.7.3 Rotor D-Axis location

The rotor d-axis location is characterized by the saliency topology.

Here is below representation of the rotor and stator phase relative position

The relative angular position between the axis of the stator phase 1 (reference phase) and the rotor D-axis position must be controlled to perform the tests.

The winding axis of the reference phase is defined from the phase shift of the first electrical harmonic of the magneto motive force (M.M.F.).

This allows defining the working point of the machine.

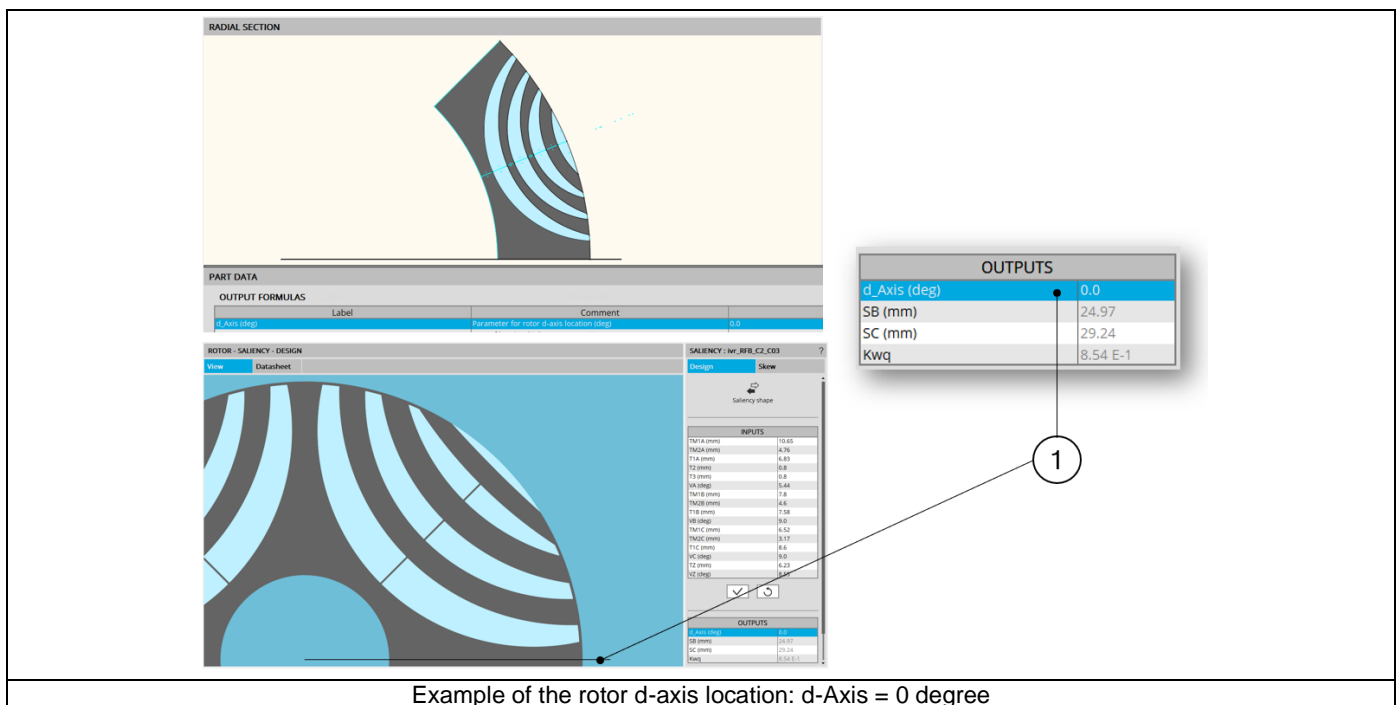
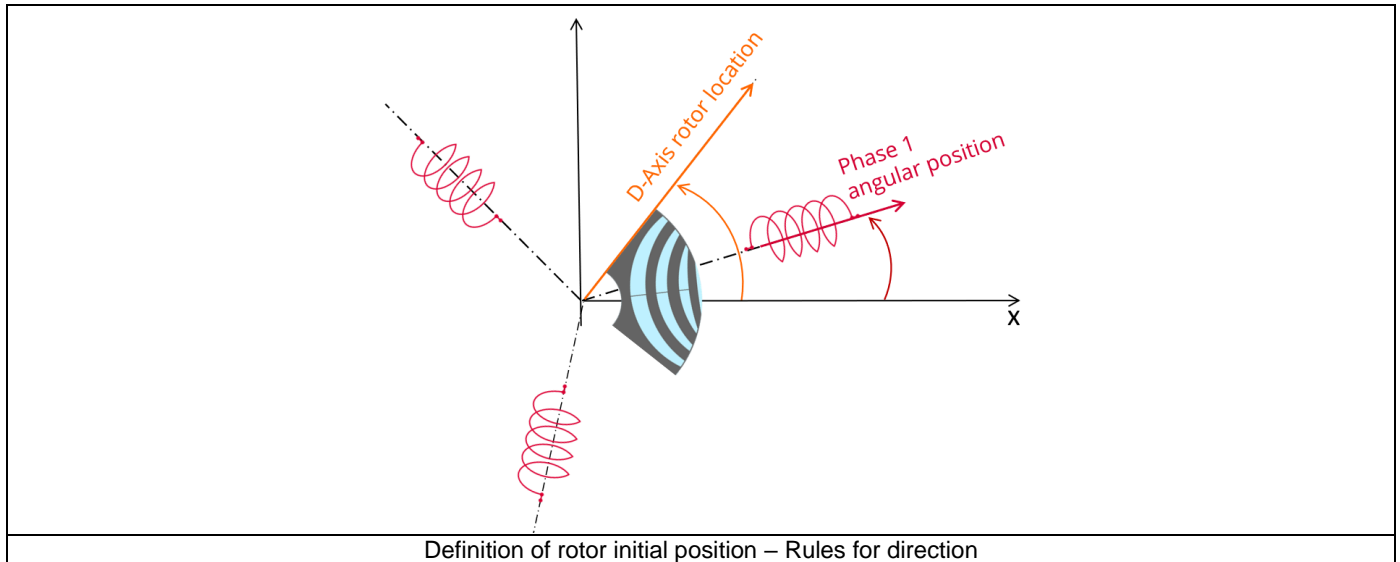

Example of the rotor d-axis location: d-Axis = 0 degree

The rotor d-axis location is an output parameter (read only data) of saliency parts. It completes the description of the topology and it is automatically used to define the relative position between the axis of the stator phase 1 (reference phase) and the rotor D-axis position for performing the tests when needed.

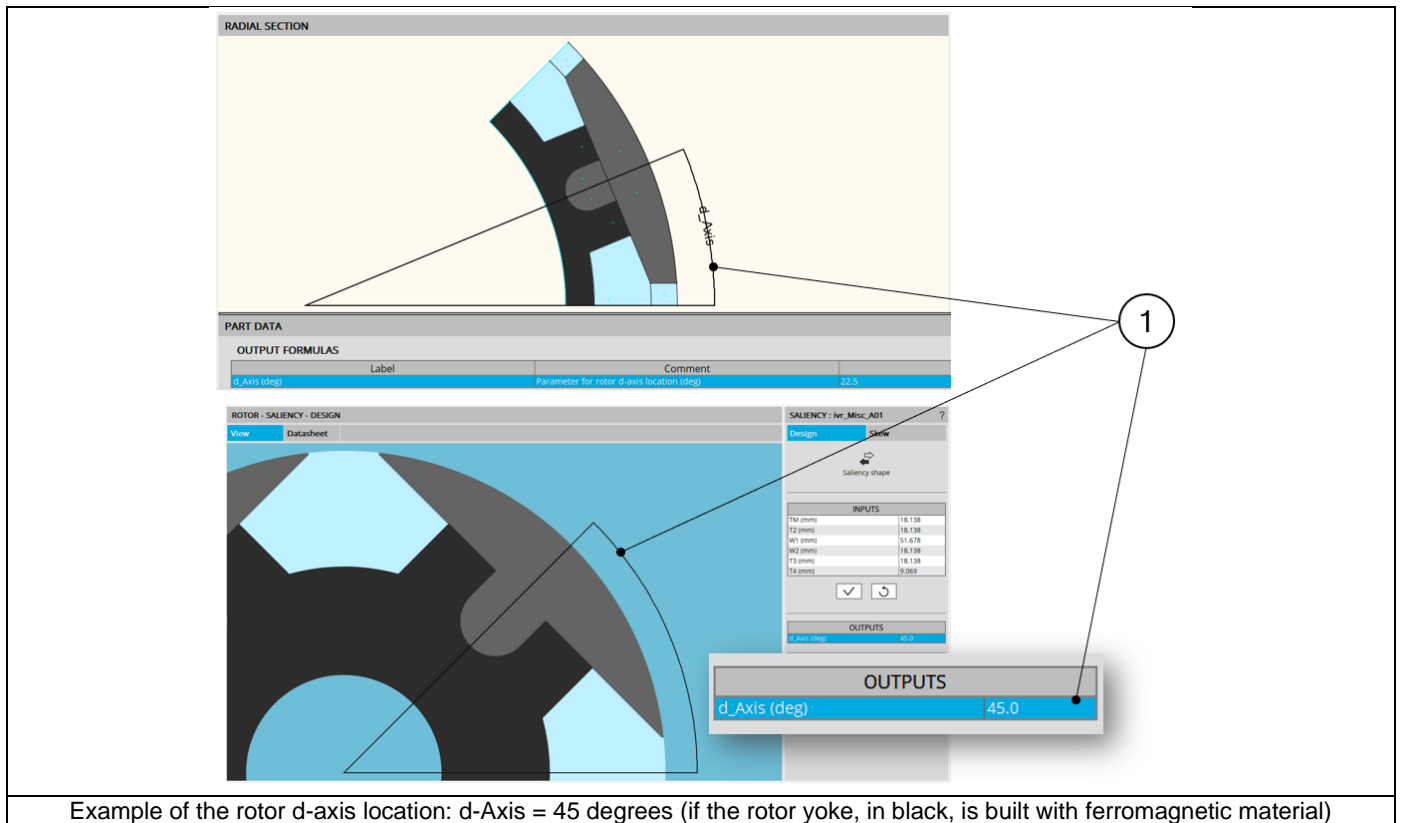

Example of the rotor d-axis location: d-Axis = 45 degrees (if the rotor yoke, in black, is built with ferromagnetic material)

2.8 Dimensions on drawing

The entire user input parameters as well as the output parameters can be illustrated in the drawing.

The elements needed to define arrows attached to the dimensions are located at the end of the Excel file where all the properties of the part are described.

However, this information is not available from Part Factory.

Only the results can be shown.

Clicking on user input parameters or output parameters makes the corresponding dimension appear on the drawing.

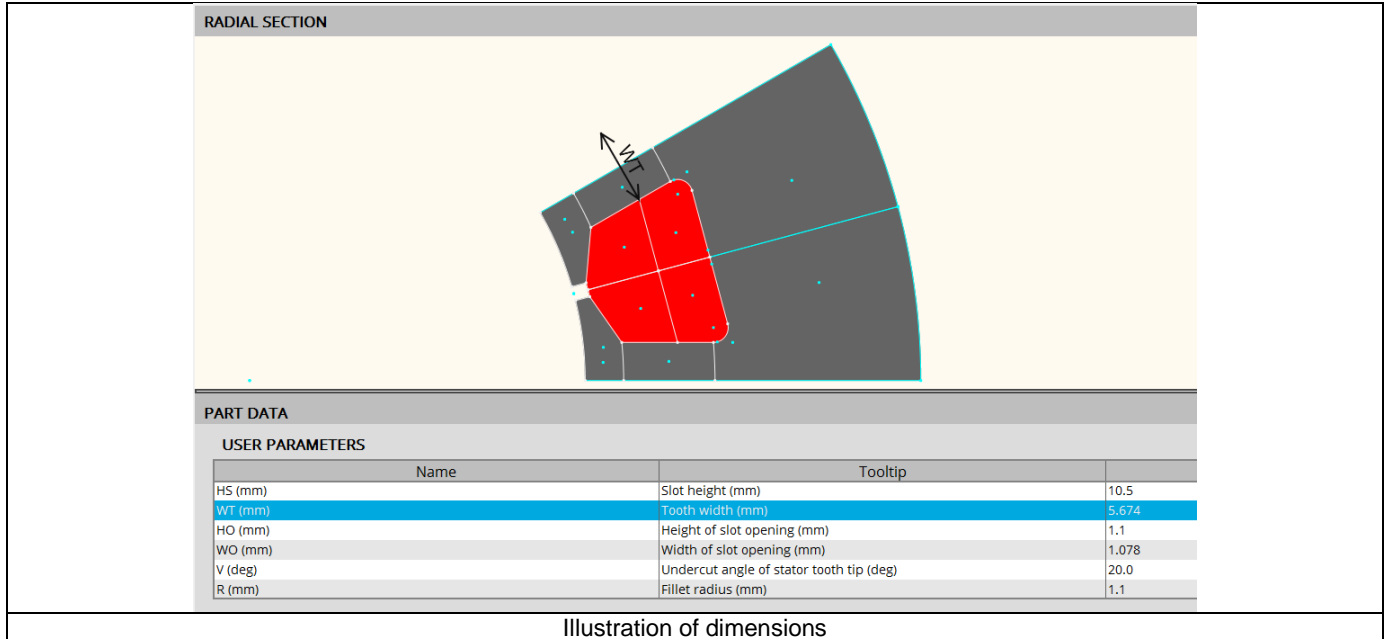

3 DESIGN

3.1 Overview

Here are the main zones that compose “DESIGN” environment of the Part Factory.

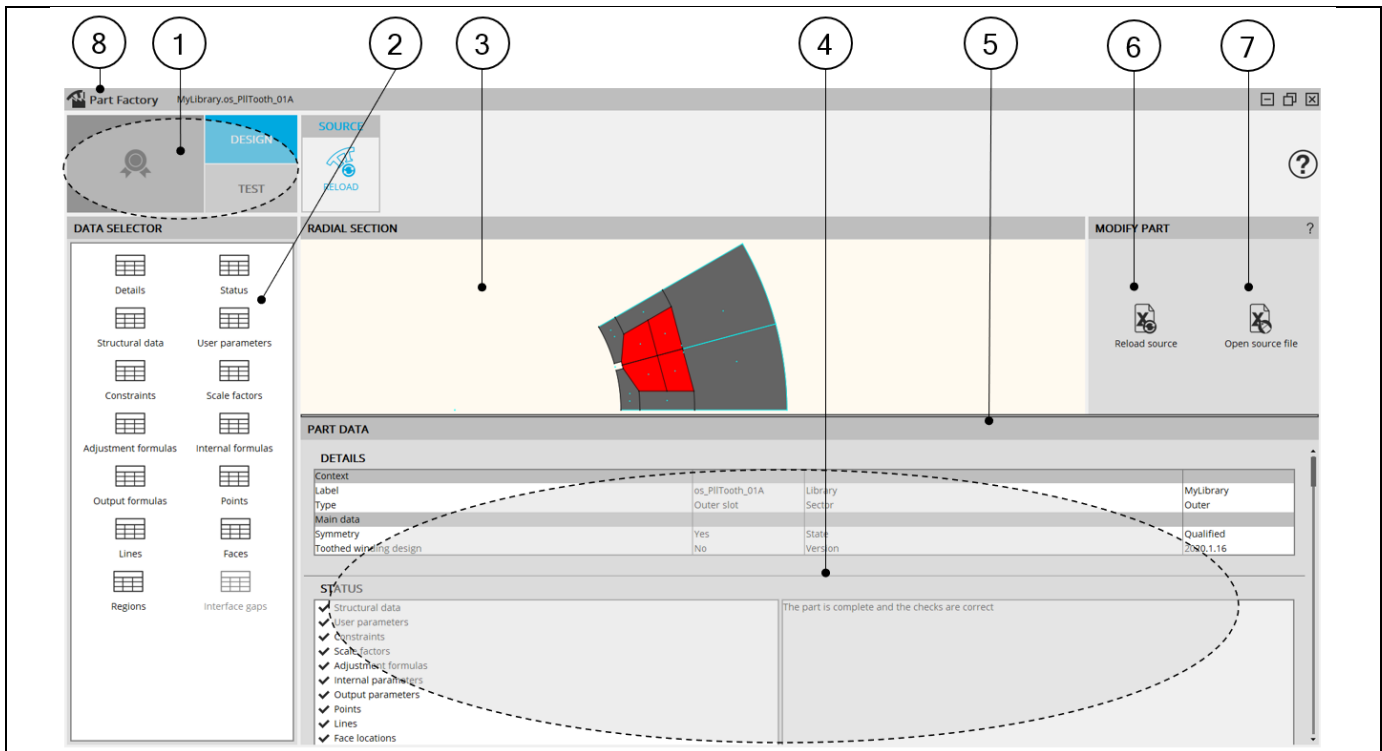

Zones of Part Factory – DESIGN area view

1	Part Factory has two main environments: DESIGN and TEST. When DESIGN is selected, it appears in blue color and it shows the part properties.
2	Shortcuts for displaying the corresponding chapter of the part properties.
3	The sector which represents the part is displayed on the central screen of the design environment of Part Factory.
4	Visualization of the part characteristics (part data described in chapters above etc.) is possible. Scrollbars allow browsing the whole document rapidly and having an overview of all the results. Using scrollbars, complete data can be accessed and visualized.
5	Dimensions of screens can be adjusted by moving the separator line between drawing and table of results.
6	Icon to reload the excel file in which all the properties of the considered parts are defined. “Reload source” means that after loading the excel file, an analysis of its contents gives a status of this part.
7	“Open source file” allows opening the Excel file associated to the considered part. It gives access to the whole definition of the part. It represents the way to customize the parts.
8	Access to the system functions by expanding the menu on the left top part of the screen. See the section dealing with the SYSTEM FUNCTIONS for more information.

3.2 Expanding the menu in Part Factory

This menu give access to two system functions: help and exit.

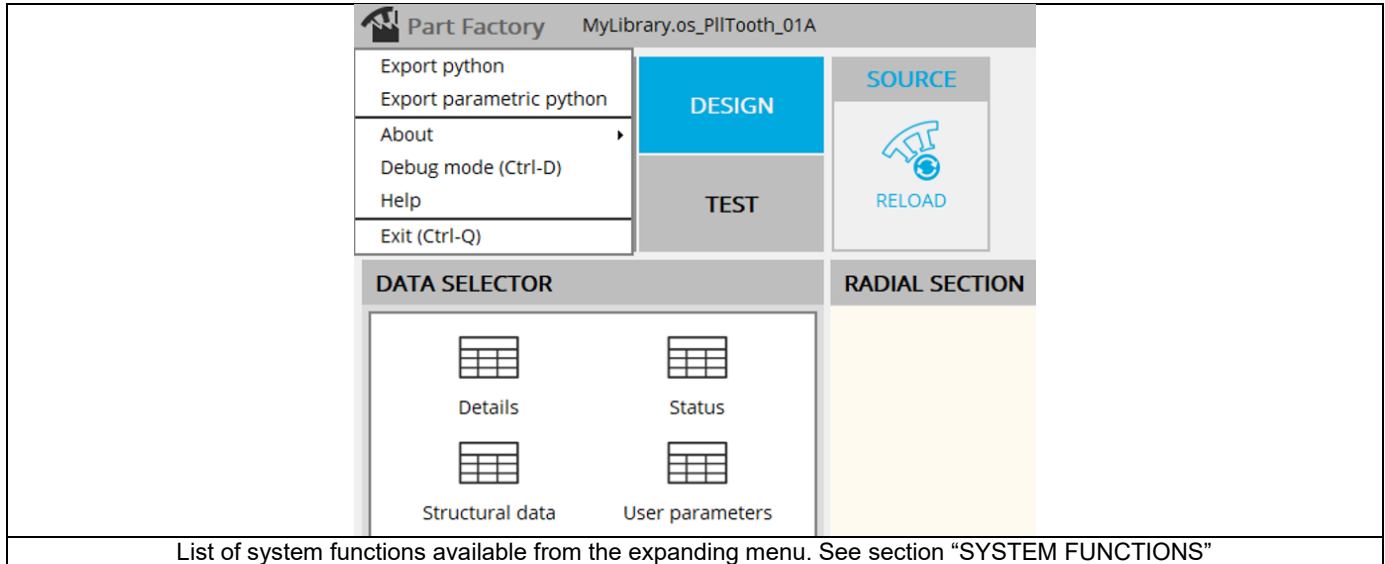

4 TEST

4.1 Overview

Here are the main zones that compose the “TEST” environment of the Part Factory:

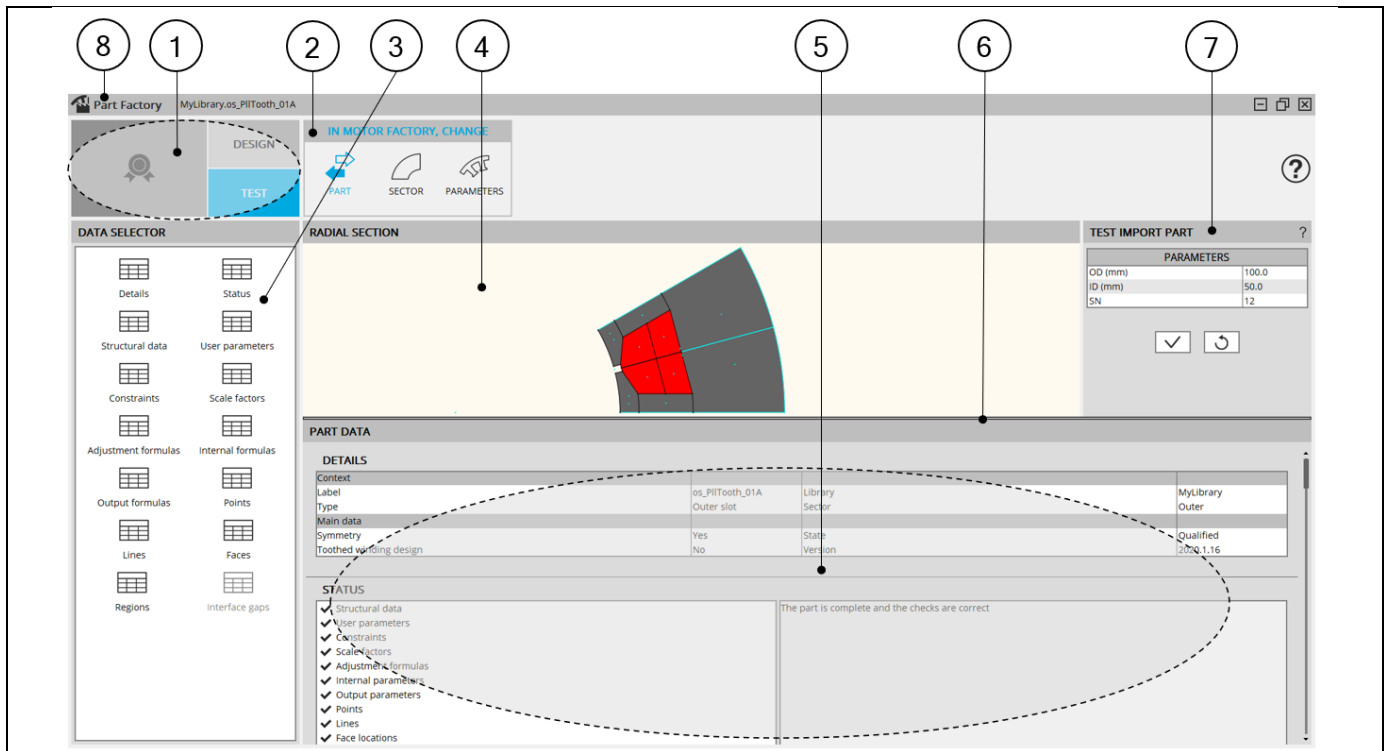

Zones of Part Factory – TEST area view

1	Part Factory has two main environments: DESIGN and TEST. When the TEST is selected, it appears in blue color and it is possible to test the behavior of the considered part.
2	Three main functions allow testing the behavior that the part will have in Motor Factory by considering the properties described in the associated Excel file. See the description of these three main functions below.
3	Shortcuts for displaying the corresponding chapter of the part properties.
4	The sector which represents the part is displayed on the central screen of the design environment of Part Factory.
5	Visualization of the part characteristics (part data described in chapters above etc.) is possible. Scrollbars allow browsing the whole document rapidly and having an overview of all the results. Using scrollbars, complete data can be accessed and visualized.
6	Dimensions of screens can be adjusted by moving the separator line between drawing and table of results.
7	User input parameters to test the three main behaviors of the considered part. See more information below.

4.2 Simulate

4.2.1 Import a part in Motor Factory

The parts are built to be used in Motor Factory.

In Motor Factory, in the DESIGN area, either in MAGNET environment, SLOT environment or BAR environment it is possible to modify the topology (the shape) based upon the inner magnet or outer slot.

This corresponds to importation of a part from "Part Library".

In Part Factory, the PART function of the test area allows testing the capability of the considered part to be imported in Motor Factory and by considering the sector defined with specific structural data.

Below is the illustration of the TEST environment and import PART function.

Test import Part	
1	Section of the first test function: PART. It allows testing the capability to import the part in a sector whose main three dimensions are defined in zone 2.
2	User input parameters to define the three main dimensions of the reference sector (structural data).
3	The sector which represents the part is displayed on the central screen of the design environment of Part Factory. In Part Factory intersection of lines can be viewed. Note: A right click on the mouse allows resetting the zoom if the part becomes invisible.
4	Validation of user input parameter values.
5	Reset of user input parameter values. The default values are defined by the properties described in the associated Excel file.

4.2.2 Modify the structural data

Inside Motor Factory, in the DESIGN area, it is possible to modify the structural data of the machine.

The modification of the structural data has an impact on the position of the part in the reference sector.
The compatibility of the new position of the part in the sector must be checked.

In Part Factory, the SECTOR function of the test area allows to test how the considered part interact with the structural data of the reference sector in which it is defined.

Below is the illustration of the TEST environment and the “SECTOR” modification function.

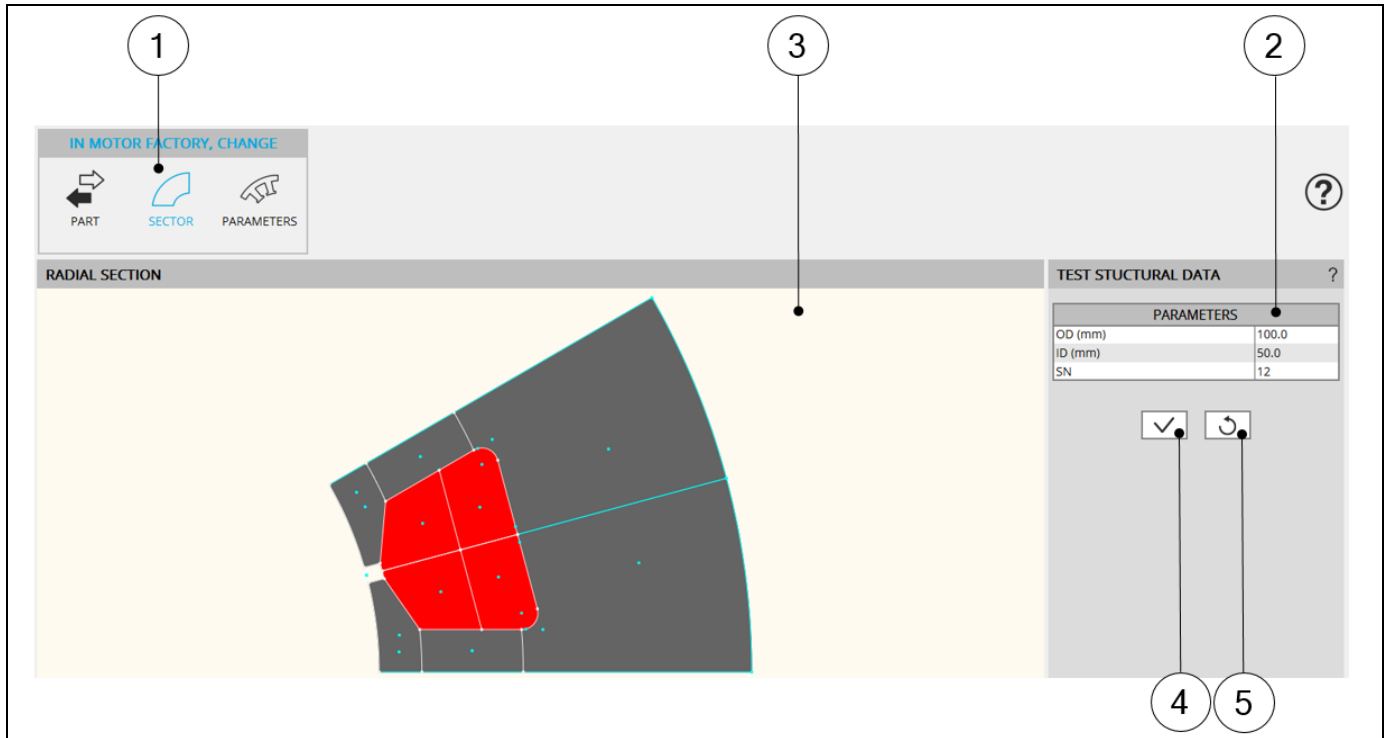

Modification of the sector parameters

1	Section of the second test function: SECTOR. It allows testing how the considered part interacts with the structural data of the reference sector in which it is defined. The user input parameters are the main three dimensions of the sector defined in zone 2.
2	User input parameters define the three main dimensions of the reference sector (structural data).
3	The sector which represents the part is displayed on the central screen of the design environment of Part Factory. In Part Factory intersection of lines can be viewed. Note: A right click on the mouse allows to reset the zoom if the part becomes invisible.
4	Validation of user input parameter values.
5	Reset of user input parameter values. The default values are defined by the properties described in the associated Excel file.

4.2.3 Modify user input parameters

The robustness of the parameterized part topology must be checked.

In Part Factory, the PARAMETERS function of the test area allows testing the robustness of the part when all its user input parameters are changed.

Below is the illustration of the TEST environment and the “PARAMETERS” modification function.

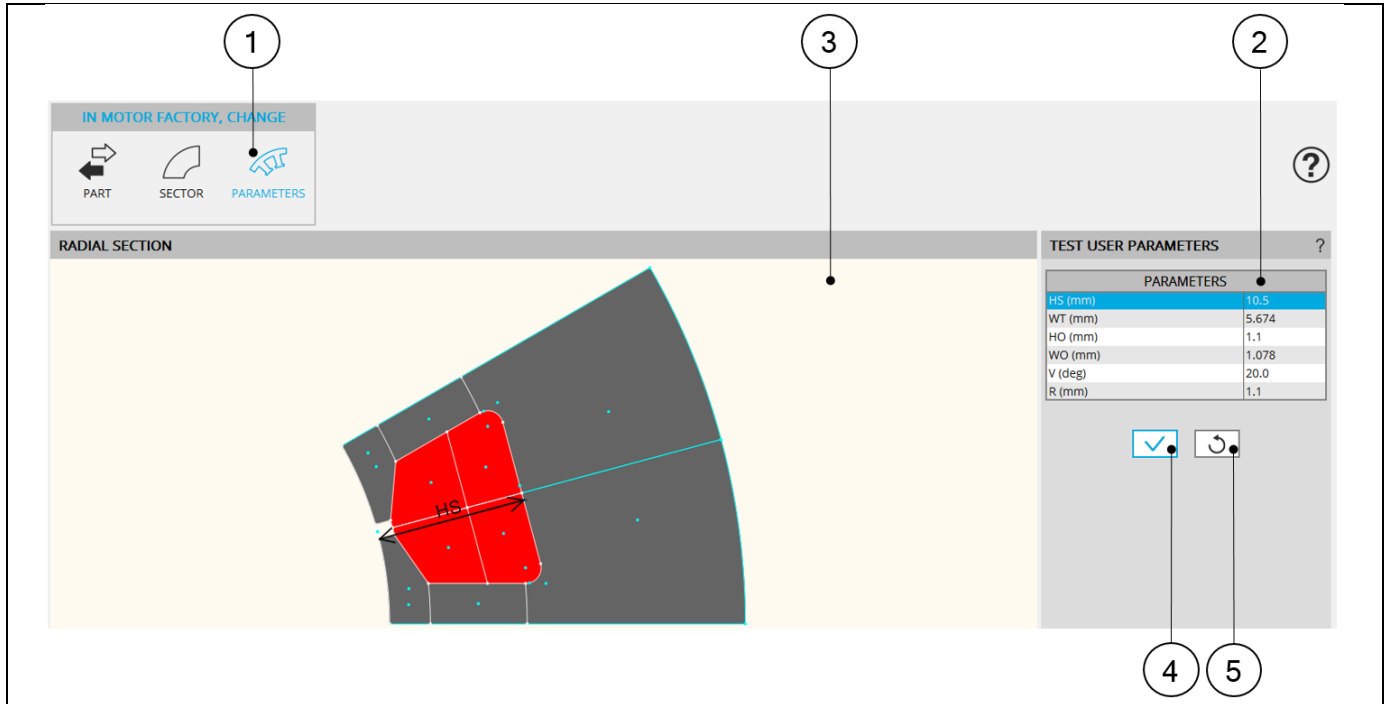

Modification of the part parameters

1	Section of the third test function: PARAMETERS. It allows testing the robustness of the part when all its user input parameters are changed. The user input parameter corresponds to the input parameter of the considered part to test.
2	User input parameters defines the dimensions of the considered part to be tested.
3	The sector which represents the part is displayed on the central screen of the design environment of Part Factory. In Part Factory intersection of lines can be viewed. Note: A right click on the mouse allows resetting the zoom if the part becomes invisible.
4	Validation of user input parameter values.
5	Reset of user input parameter values. The default values are defined by the properties described in the associated Excel file.

5 SYSTEM FUNCTIONS

5.1 Overview

System functions are accessible from the top menu of Part Factory.

Expanding the menu in the left top part of Part Factory from any area: DESIGN or TEST allows to visualize and to select these functions.

The main ways to access to these functions are illustrated below.

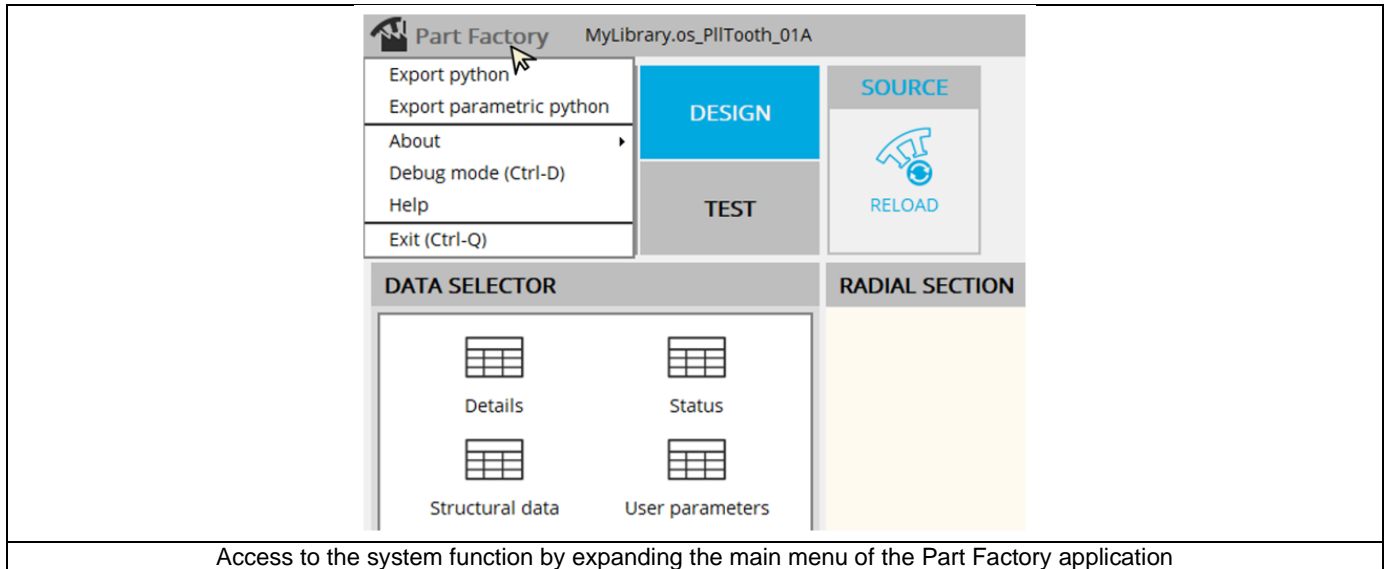

5.2 User actions

5.2.1 Export python and parametric python

From Part Factory, it is possible to export a python file that allows the user to build the Flux® model of the considered part. To do that, FluxMotor® provides a python file that must be used in Flux® environment. To see the process, refer to the chapter dedicated to Flux® environment.

Two models are proposed to be exported: one without user parameters, in which all dimensions are fixed and another one with all the parameters needed to build the part available for the users.

In both cases the resulting Flux® model (parameterized or not) is ready to be used in Flux® 2D environment.

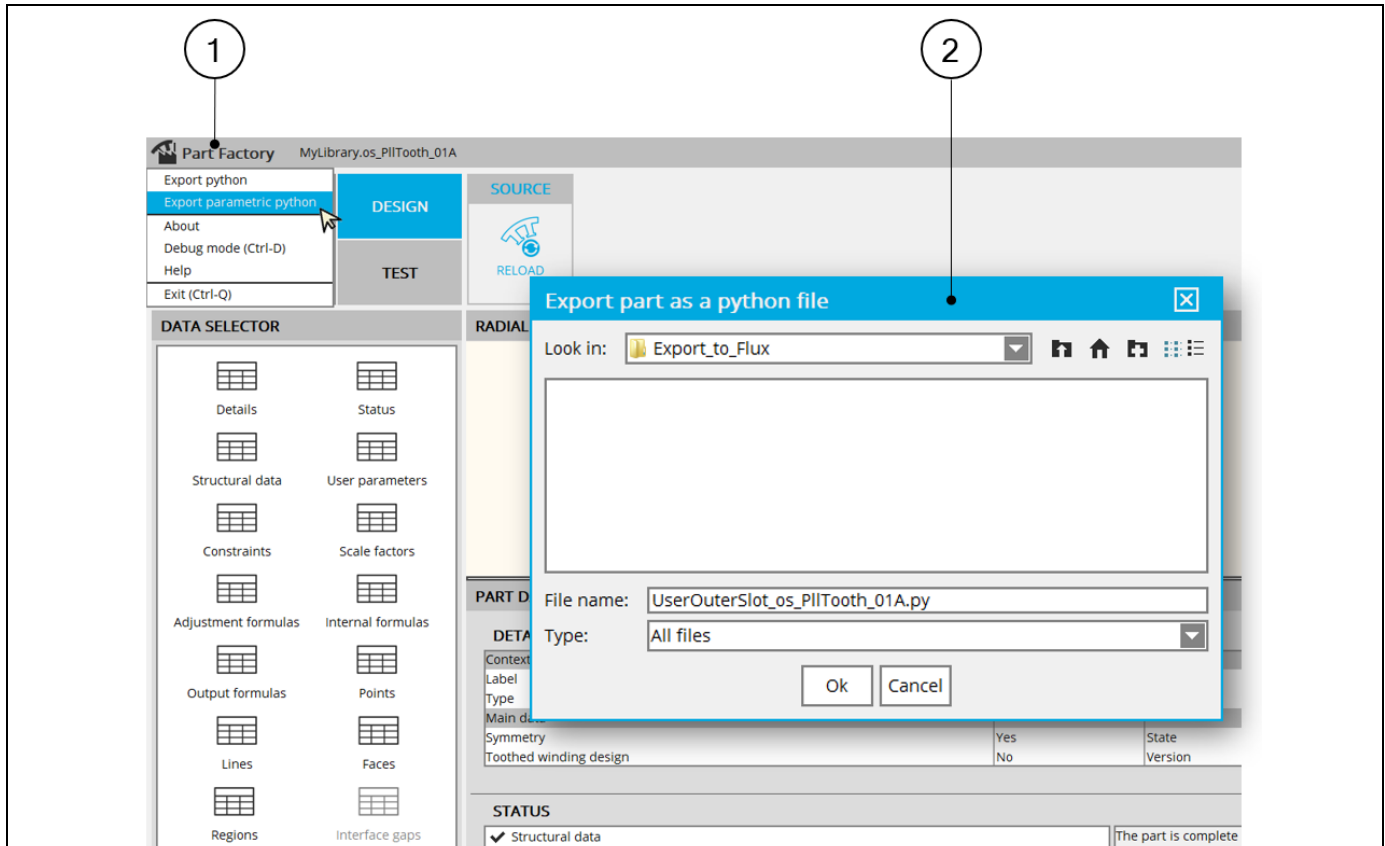

How to export a python file to Flux® software environment

1	From the top menu of Part Factory select “Export python” or “Export parametric python”.
2	A dialog box allows choosing the folder in which the python file will be stored.

5.2.2 Debug mode function

The Debug mode function is dedicated to solving of the problem with the use of Motor factory. In case of a trouble, instructions will be given by our support team to use this function.

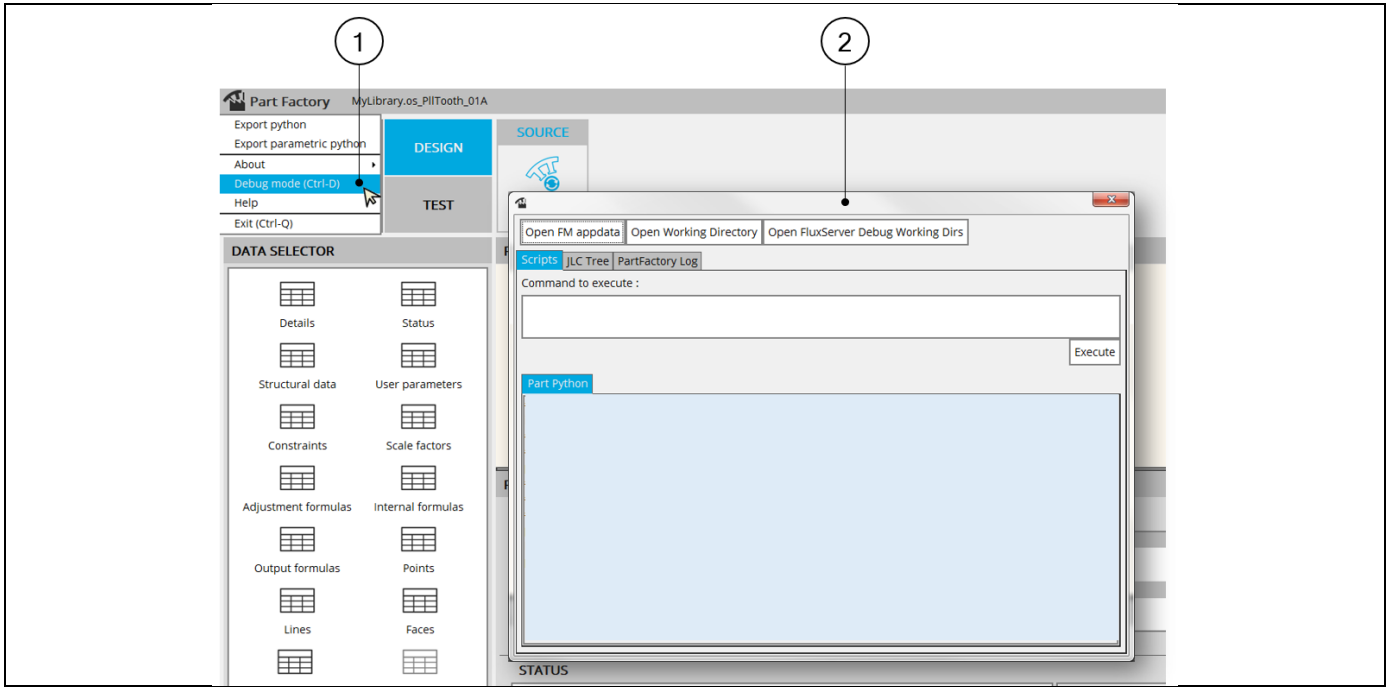

Undo function

1	Access to the “Debug mode” from the top menu of Part Factory.
2	Dialog box corresponding to the “Debug mode” function.

5.2.3 Exit

Closing Part Factory is possible

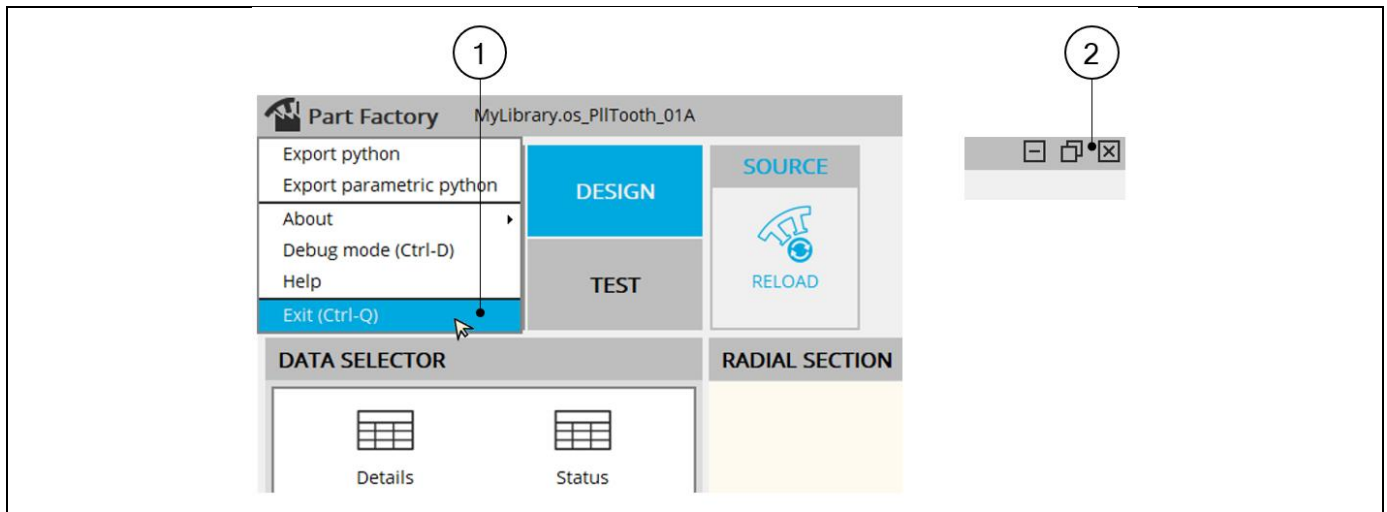

Exit – Close Part Factory

1	Close Part Factory from the top menu of Part Factory.
	Close Part Factory by using the following icon on the right top part of the Part Factory panel.
*	Close Part Factory by using the shortcut CTRL-Q defined in the user preferences. For more information, refer to the chapter “user’s preferences”.